

MADE IN FRANCE
MANUFACTURER SINCE 1964



Car Body Welding System

Catalogue Carrosserie • Karosserie-Schweißtechnik Katalog
Catálogo de Soldadura para Carrocería

2017 B

www.gys.fr

SPOTTER • DENT PULLER • MIG • PLASMA • INDUCTION • LIFT • RIVETING • ACCESSORIES



A family firm since 1964

Une société familiale depuis 1964
 Familienunternehmen seit 1964
 Una empresa familiar desde 1964
 Un'azienda familiare dal 1964
 Een familiebedrijf sinds 1964

3



40 000 m²
 400 000 sqf



9



600



110



Partenaires • Partners • Asociados • Partner



High tech R&D

R&D de pointe
Hochmodernes F&E
I+D de tecnología punta
R&S di punta
Hoogwaardige R&D

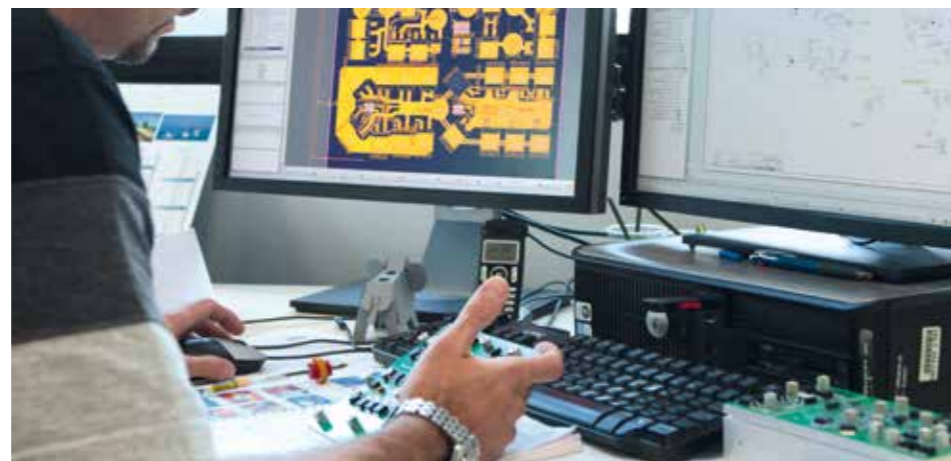

GYS Academy

Académie • Akademie
Academia • Accademia
Academy

Centre de formation agréé
Training centre dedicated to professionals
Trainingcenter für Profis
Centro de formación autorizado
Centro di formazione dedicato ai professionisti
Erkend opleidingscentrum

Formations agréées
Ref. 52 53 0068153

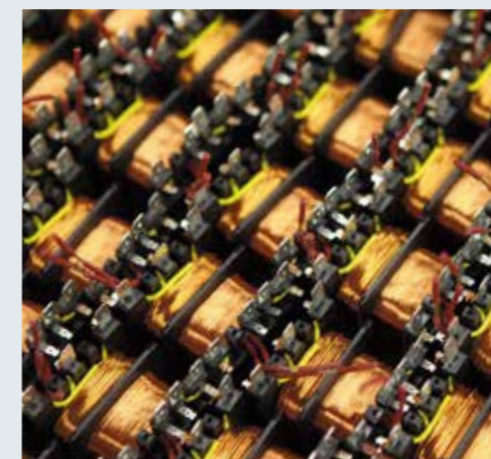

100% GYS

GYSPT 2600 Acier/Steel /Stahl 230V
2600 A

052208



OPTION SPOTTER BOX 2600
052277

Chariot-trolley SPOT 600 053533



Automatic

GYSPT 2700 Acier/Steel /Stahl 230V
2600 A

055353



OPTION SPOTTER BOX 2700
053922



2m

CARBON HEATING ELECTRODE 049468

Manual

INCLUDED MANUAL QUICK GUN 2700 058705

QUICK GUN

QUICK & EASY

Gyspot 2600/2700
 Gyspot 39.02/04
 Gyspot PRO 230/400
 Gyspot EXPERT 200/400
 Gyspot COMBI 230 E.PRO



NEW 2017



GYSPT 39.02 Acier/Steel /Stahl 230V 052215

GYSPT 39.04 Acier/Steel /Stahl 400V 052222

3800 A

INCLUDED SPOTTER BOX STANDARD 053915 Details p.12



4m

2m Ø70mm²

2m Ø70mm²

Automatic

INCLUDED AUTOMATIC QUICK GUN 057517

SYNERGIC CONTROL

PATENTS REGISTERED NUMBERS EUROPEAN TRADEMARK & DESIGN



GYSPT PRO 230 Acier/Steel /Stahl 230V 052178

GYSPT PRO 400 Acier/Steel /Stahl 400V 052185

3800 A

2 GUNS



8m

2m Ø70mm²

INCLUDED SPOTTER BOX PRO 050075 Details p.12

INCLUDED



Automatic

AUTOMATIC QUICK GUN 057500

049802

3m Ø50mm²

Manual

MANUAL QUICK GUN 057524

2m Ø70mm²

PATENTS REGISTERED NUMBERS 001830845-0001 EUROPEAN TRADEMARK & DESIGN

GYSPT EXPERT 200 Acier/Steel /Stahl 200/240V 058842

GYSPT EXPERT 400 Acier/Steel /Stahl 400V 058859

5000 A

2 GUNS



8m

2m Ø70mm²

INCLUDED SPOTTER BOX PRO 050075 Details p.12

NEW 11/2017

SYNERGIC & MANUAL CONTROL



COMING SOON

MADE IN FRANCE 60974/1	50/60 Hz	I ₂ max A	U ₂ V	-AM- A	I _{RMS} A	kW	OK	MANUAL	SYNERGIC	AUTOMATIC	MANUAL	SEPARATE CABLE GUN	1,8m	Auto	2m	Option Spotter box 2600	20 x 32 x 18	14	
																			2m
GYSPT 2600	230V	2600	5,4	16	1800	10	OK	—	—	—	—	—	1,8m	Auto	—	2m	Option Spotter box 2600	20 x 32 x 18	14
GYSPT 2700	230V	2600	5,4	16	1800	10	OK	—	—	—	—	—	1,8m	—	—	2m	Option Spotter box 2700	20 x 32 x 18	14
GYSPT 39.02	230V	3800	7,4	16	2800	20	OK	OK	—	—	—	—	2m	Auto	—	4m	Included Spotter box	22,5 x 36 x 23,5	23
GYSPT PRO 230	230V	3800	7,4	16	2800	20	OK	OK	—	—	—	—	2m + 3m	Auto	—	8m	Included Spotter box (with studs)	22,5 x 36 x 23,5	25,5
GYSPT EXPERT 200	200 > 240V	4600-5600	7,4	30	3300 > 4000	25 > 36	OK	OK	—	—	—	—	2m + 3m	Auto	—	8m	Included Spotter box (with studs)	22,5 x 36 x 23,5	25,5
GYSPT 39.04	400V, 2ph	3800	7,4	16	2800	20	OK	OK	—	—	—	—	2m	Auto	—	4m	Included Spotter box	22,5 x 36 x 23,5	23
GYSPT PRO 400	400V, 2ph	3800	7,4	16	2800	20	OK	OK	—	—	—	—	2m + 3m	Auto	—	8m	Included Spotter box (with studs)	22,5 x 36 x 23,5	25,5
GYSPT EXPERT 400	400V, 2ph	5300	8,8	16	3800	35	OK	OK	—	—	—	—	2m + 3m	Auto	—	8m	Included Spotter box (with studs)	22,5 x 36 x 23,5	25,5



GYSPT ALU PRO FV Alu **110 > 230V**
7 500 A

GYSPT COMBI 230 E.PRO Acier/Steel /Stahl **+** Alu 230V
3 800 A **7 500 A**

021990

021266

SYNERGIC CONTROL
Alu

SYNERGIC CONTROL
Acier/Steel/Stahl

NEW
SOFT



PATENTS REGISTERED NUMBERS
EUROPEAN TRADEMARK & DESIGN

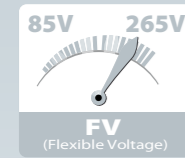

Process Alu

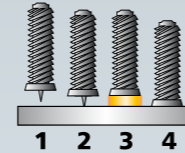

Alu Gun
Easy



INCLUDED
ALU BOX
STANDARD
050020
Details p.12



NEW 2017

Anneaux de tirage rapide - Fast pulling rings - Aufsteckzugöse selbstarretierend
058743

x5 058712 + Alu 3 058729 + Alu 4 058736

goujons alu - alu screws ø 4,5 & 6 mm



INCLUDED
SPOTTER BOX PRO 050075
+ ALU BOX STANDARD 050020
Details 12-13

QUICK GUN

QUICK & EASY
NEW 2017

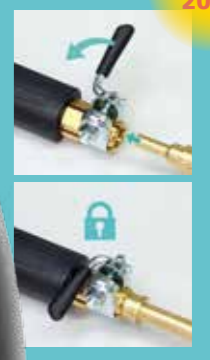

8m

2m
Ø70mm²

3m
Ø50mm²

INCLUDED
QUICK AUTOMATIC
GUN
057500

PATENTS REGISTERED NUMBERS
00183045-0001
EUROPEAN TRADEMARK & DESIGN

2m
Ø70mm²

INCLUDED
MANUAL
QUICK GUN
057524

PATENTS REGISTERED NUMBERS
002446450-0001
EUROPEAN TRADEMARK & DESIGN

INCLUDED
AUTOMATIC
ALU GUN
054066
3m
Ø25mm²

3 GUNS INCLUDED

Options (more p.18-19)

Marteaux ALU - Alu hammers 020986	Alu Puller 051003	Slide hammer 050051	Lampe à souder - Blow torch - Lotlampe 052741	Novacet + (Butane/propane/propylene) 380ml/220g 040441	Crayon marqueur thermique - Thermal marking pencil 121°C / 250°F 052765	Thermomètre infrarouge - Infrared Thermometer - Infrarot Thermometer -50 / +380 °C -58 / +716 °F 052994
-----------------------------------	-------------------	---------------------	---	--	---	---

MADE IN FRANCE 60974/1	SYNERGIC	GUN		SEPARATE CABLE GUN	U ₂ V	I _{AM} A	I _{RMS} A	kW	OK	OK	cm	kg	
		Acier/Steel	Alu										
GYSPT ALU PRO FV	110>230V	7500	—	AUTOMATIC	—	50 > 200	5	—	0,65	OK	OK	21 x 24 x 36	14
GYSPT COMBI 230 E.PRO	230V	3800 (steel) 7500 (alu)	x2	AUTOMATIC + MANUAL	AUTOMATIC	7,4 (steel) 20 > 200 (alu)	16	2800 (steel)	20	OK	OK	45 x 43 x 29	49,7

DENT PULLING • DÉBOSSÉLAGE

MARTEAUX INERTIE - Slide hammers - Ausziehhammer

1,1 kg 049802
COMPLETE 057272

(x20) 052239
(x1) 049482
(x1) 054028 (x5) 050839

1,1 kg 041813
Clous - Nails - Nägel
Ø 2, M4 (x1) 049277
Ø 2 (x100) 041561
MIG/MAG nozzle for Nail welding 041523

1,7 kg 051201
Rondelles - Washers - Ringe
Ø 16,8x16 (x1) 049574
(x1) 051218
8x16 (x100) 049444

Griffes - Gripping hook head - Ausbeulkit 049819
2,5 kg

COMPLETE KIT 051225

(x1) (x50)
(x1) (x25)

LEVIER DE DÉBOSELAGE - Levelling lever - Zughebel

PATENTS REGISTERED NUMBERS: 001652108-0002
EUROPEAN TRADEMARK & DESIGN

050686

(x2) 052451

55 mm

BARRE DE DÉBOSELAGE DOUBLE ACTION - Levelling bar double action - Zughebelbrücke

053564

0,86 m

Barre de traction - Traction bar - Zugstange
Barre renforcée - Strengthened bar
1,20 m 051171

Support double patin - Double pads support - Doppelfüße
NEW DESIGN 050723

BARRE DE DÉBOSELAGE - Levelling bar - Zugbrücke

050693

0,85 m

Support double patin - Double pads support - Doppelfüße
NEW DESIGN 050723

BARRE DE TIRAGE RENFORCÉE - Scissoring bar - Scherenzugbrücke

050716

Barre renforcée - Strengthened bar

(x1) 058439 (x1) 056794 (x1) 056800

PATENTS REGISTERED NUMBERS: 001652108-0001
EUROPEAN TRADEMARK & DESIGN

(x2) 052451

55 mm

Barre de traction - Traction bar - Zugstange
Barre renforcée - Strengthened bar
1,20 m 051171

Support double patin - Double pads support - Doppelfüße
NEW DESIGN 050723

057319

Griffes 2 dents 057296

Ø M10 / M14 049758

Poignée de tirage 2 dents

Griffes - Gripping hook head - Ausbeulkit

6 Ø M10 / M14 049734

8 Ø M10 / M14 049741

MANUSPOT 050679

for SPOT 600, 800, 1000, 1600 & Workstation

PATENTS REGISTERED NUMBERS: 001652108-0003
EUROPEAN TRADEMARK & DESIGN

3 m Ø 35 mm²

4 positions • 4 Positionen

EASY TOOL CONNECTION

Gyspot 39.02/04 + Gyspot PRO230/400
GYSPOT COMBI 230 PRO

EASY GUN 051317

051584 380 g

Anneaux - Rings - Anschweißösen 051652

Fils ondulés - Wavy wires - Wellendraht 051669

Rétreinte - Tempering - Glättwerkzeug 051676

OPTION 057289

MANULINER/GUN 056831

Adaptér for gun included (Ref. 052499)

PATENTS REGISTERED NUMBERS: 001652108-0003
EUROPEAN TRADEMARK & DESIGN

4 positions • 4 Positionen

MANULINER 050471

050471

051690

EASY TOOL CONNECTION

Gyspot 39.02/04 + Gyspot PRO230/400
GYSPOT COMBI 230 PRO

EASY GUN 051317

051584 380 g

Anneaux - Rings - Anschweißösen 051652

Fils ondulés - Wavy wires - Wellendraht 051669

Rétreinte - Tempering - Glättwerkzeug 051676

EASY TOOL CONNECTION

Gyspot 39.02/04 + Gyspot PRO230/400
GYSPOT COMBI 230 PRO

POIGNÉE DE TIRAGE MANUEL

OPTION 057289

RINGMATIC 052154

included (x 50)

052154

QUICK SPOT AIR GUN 052352

Pneumatic

2,5 m

AIR

Light weight 920 g

052352

MANUSPOT / MANULINER / QUICK SPOT AIR GUN

Direct impact electrodes (x5) 050839

MANUSPOT/MANULINER

Box of 3 electrodes for accessories 050822

OPTION - ADAPTATEUR POUR PISTOLET - Adapter for gun

For RINGMATIC & MANUSPOT 052499

Adaptateur texas For QUICK SPOT AIR GUN

052826

LAMPE LIGNE DROITE - Straight line lamp - Dentline-laser

056770



CONSOMMABLES ACIER - Steel consumables - Stahl-Verbrauchsmaterial



BEST SELLER

DENT BOX BAR
050037



SPOTTER BOX 2600
052277



SPOTTER BOX 2700
053922

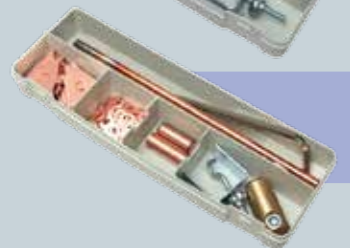

SPOTTER BOX STANDARD
053915

x 25		WAVY WIRES x 50 049727	x 25
x 50		STRAIGHT PULLING RINGS x100 050648	x 50
x 1		LIFTING ROD x3 050792	x 1
x 1		ELECTRODE FOR WAVY WIRES x 1 049789	x 1
x 1		ELECTRODE FOR RINGS x 1 050655	x 1

x 20		STAR WITH COPPER COATING x 20 052239	Dent Box Easy x 10 Spotter Box Pro x 20
x 1		ELECTRODE FOR RINGS ø 16 - 8 x 16 x 1 049574	x 1
x 50		CENTERING RINGS ø 8 x 16 x 100 049444	x 50
x 1		EARTH HOOK x 1 056718	x 1
x 1		CARBON HEATING ELECTRODE x 5 049468	x 1
x 1		STAR-CHUCK FOR INERTIA HAMMER x 1 049482	x 1
x 1		HEXAGON KEY	x 1
x 1		EARTH PLATE	x 1
x 1		ELECTRODE WARMING POINT - ø 16 x 1 049567	x 1

x 1		ELECTRODE FOR AUTO-THREADED RIVETS ø 5 - M5, M6 x 1 049598	x 1
x 1		ELECTRODE FOR RIVETS ø 16, 3 x 4,50 x 1 049604	x 1
x 50		THREADED STUDS M5 x 18 x 0,8 x 100 049383	x 50
x 50		SELF-THREADING STUDS ø 5 x 18 x 100 049420	x 50
x 50		SELF-THREADING STUDS ø 5 x 12 x 100 049413	x 50
x 100		RIVETS - ø 3 x 3,25 x 100 049345	x 100
x 100		RIVETS - ø 3 x 4,50 x 100 049352	x 100

more

	SQUARE LOCK NUT - M8 (x100) 050303		SINGLE HOOK (x1) 051218
	MAGNETIC POSITIONER (x1) 049772		ELECTRODE WHEEL ø16 (x1) 050310
	MAGNETIC EARTH (x1) 049666		EARTH PLATE (x1) 052529
	ELECTRODE FOR MAGNETIC EARTH (x1) 050013		ELECTRODE FOR NAILS ø 2 - M4 (x1) 049277
	THREADED ROD FOR MAGNETIC EARTH (x5) 055438		NAIL Ø2 (x100) 041561
			FLAT KEY N°27 049673

DENT BOX EASY
053632

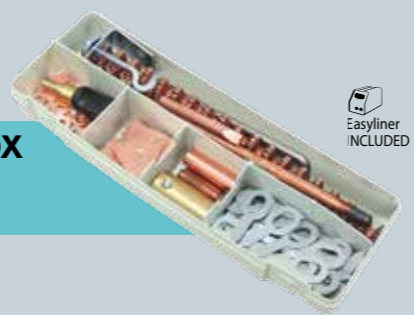

Easyliner INCLUDED

SPOTTER BOX PRO
050075



Pro 230 Pro 400 Expert 200 Expert 400 Combi 230 INCLUDED

BEST SELLER

DENT BOX CONSUMABLES
051515

x 25		WAVY WIRES x 50 049727
x 20		STARS WITH COPPER COATING x 20 052239
x 50		STRAIGHT PULLING RINGS x 100 050648
x 25		TWISTED PULLING RINGS x 50 050631

CONSOMMABLES ALU - Alu consumables - Alu-Verbrauchsmaterial



ALU BOX LIGHT (Ø4)
051522

x 200		ALU MAGNESIUM SCREWS 12 mm - ø 4 - M4 x 200 050273 x 1000 050129
-------	--	--



ALU BOX STANDARD (Ø4)
050020

x 200		ALU SILICON SCREWS 12 mm - ø 4 - M4 x 200 050280 x 1000 050136
-------	--	--

x 5		SCREWABLE RINGS ø 4 x 5 050297
-----	--	--------------------------------------

x 1		LIFTING ROD x 3 050792
-----	--	------------------------------

Gyspot Alu Combi 230 INCLUDED

ALU BOX Ø5 & 6
048195

	MANDREL FOR ALU GUN	ø 5	048157	x 1
		ø 6	048164	x 1
	ALU MAGNESIUM SCREWS 12 mm	ø 5	048140	x 100
		ø 6	048133	x 100
	ALU SILICON SCREWS 12 mm	ø 5	048126	x 100
		ø 6	048003	x 100
	SCREWABLE RINGS	ø 5	052635	x 5
		ø 6	052628	x 5

more (Ø4)

	MANDREL FOR ALU GUN - Ø 4 (x2) 049000		x1 050945
	TENSION MANDREL FOR M4 (x1) 050327		x1 050938

ANNEAUX DE TIRAGE RAPIDE

- Fast pulling rings - Aufsteckzugöse selbstarretierend
058743

NEW 2017

x5 058712

+ Alu 3 058729

+ Alu 4 058736

goujons alu - alu screws ø 4, 5 & 6 mm

MANDRINS POUR PISTOLETS - Mandrels for gun - Pistole mit Anschlussstücke, Zubehör

Pour débosseurs - for dent pullers - Anschlussstück für Ausbeulspotter-Pistole

QUICK GUN 057531

D1 048959

Pour soudeuses par point - for spot welding machines - Anschlussstück für Monopunktpistole

S1 (< nov 2010) 048171

S2 - NEW (> nov 2010) 048188

Écrou - Nut 053199

Microswitch 053267

MASSE PISTOLET ACIER - Steel gun earth adapter - Masse für Stahl Pistole

051997

Ø 25mm²

AFFÛTEUR PNEUMATIQUE D'ANNEAUX - Pneumatic Bit Cutter

056763

Made in P.R.C.

pour anneaux de tirage droits ou torsadés - for straight or twisted pulling rings



Acier/Steel/Stahl

EASYLINER

2700 (230 V)	39.02 (230 V)
2 600A	3 800A
055445	053618

GYSPT 2700 GYSPT 39.02

+ +

Trolley SPOT 1000 053540

Dent box easy 053632 (p.13)

0,86 m

Levelling bar double action 053564 (p.10)

ALL IN 1 BOX

Acier/Steel/Stahl

PROLINER

39.02 (230 V)	39.04 (400 V)	PRO 230 (230 V)	PRO 400 (400 V)
035775	035782	035799	035805

GYSPT 39.02 GYSPT 39.04 GYSPT PRO 230 GYSPT PRO 400

+ + + +

Trolley SPOT 800 051331

Cable support 052284

0,86 m

Levelling bar double action 053564 (p.10)

Dent box bar 050037 (p.12)



Spot 600
053533

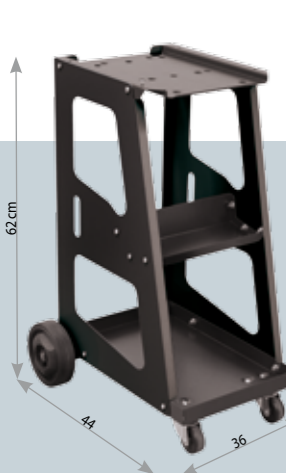

Spot 800
051331

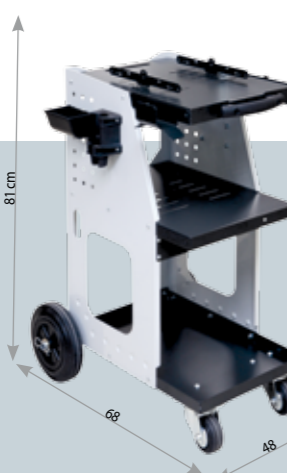

Spot 1000
053540



Spot 1600
051348



Workstation
050747



Dentstation PRO
056848



OPTIONS

- Manuliner 050471
- Ringmatic 052154
- QUICK SPOT AIR GUN 052352







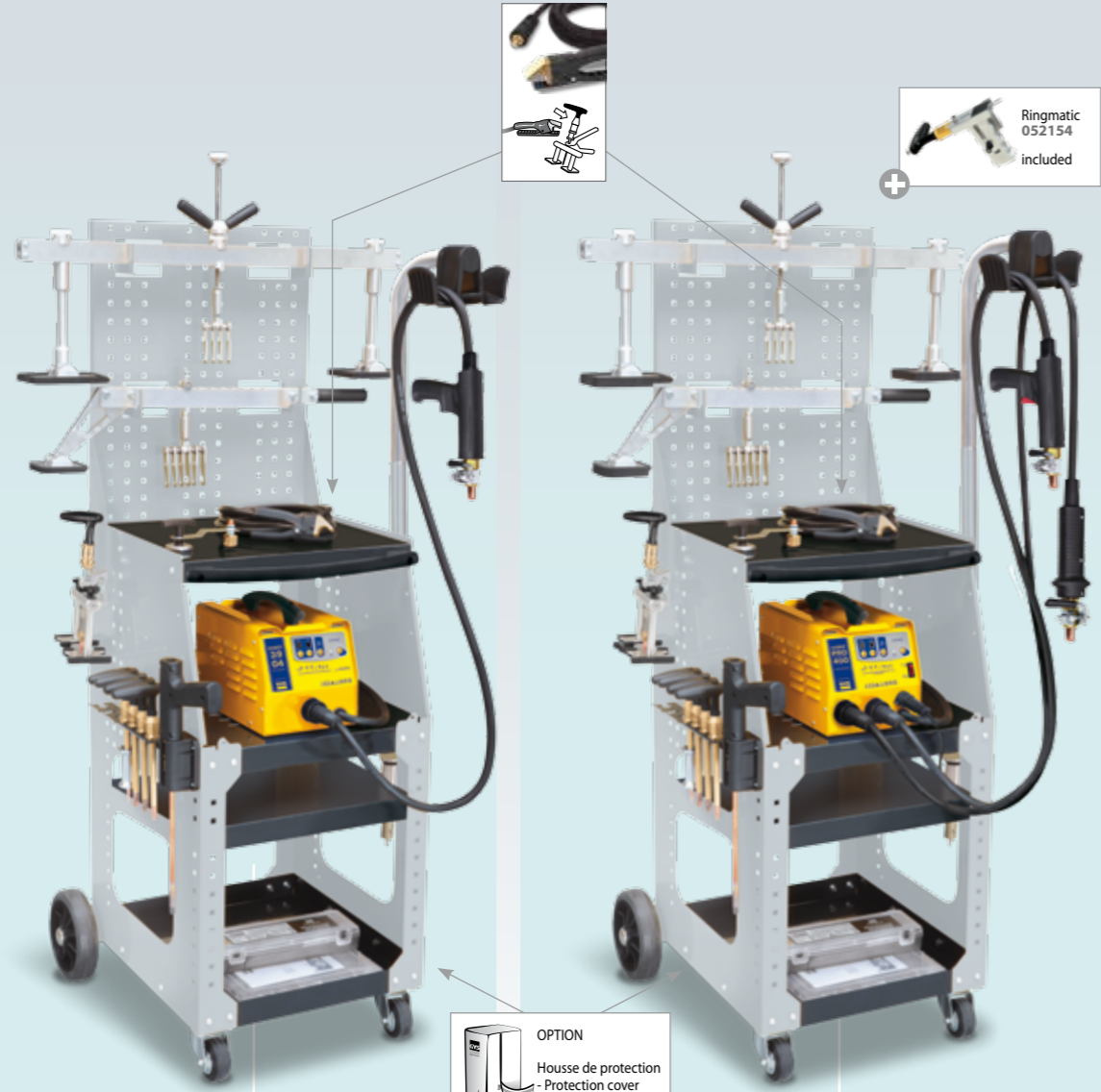



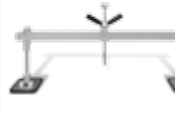

Acier/Steel/Stahl			
SPEEDLINER	SPEEDLINER	SPEEDLINER	SPEEDLINER
39.02 (230V)	39.04 (400V)	PRO 230 (230V)	PRO 400 (400V)
035010	035027	036017	036024

Acier/Steel/Stahl			
GYSLINER	GYSLINER	GYSLINER	GYSLINER
39.02 (230V)	39.04 (400V)	PRO 230 (230V)	PRO 400 (400V)
035096	035102	036031	036048

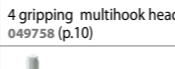
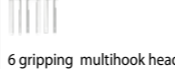

OPTION
Housse de protection
- Protection cover
- Schutzhaube
048881

-  Trolley SPOT 1600 051348
-  Manuspot 050679 (p.11)
-  Levelling bar 050693 (p.10)
-  Levelling lever 050686 (p.10)
-  052451 (p.10)
-  4 gripping multihook head 049758 (p.10)
-  6 gripping multihook head 049734 (p.10)
-  3 lifting rods 050792 (p.12)
-  Dent box consumables 051515 (p.13)
-  Magnetic earth 049666 (p.12)

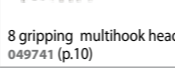
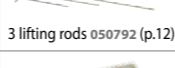
-  Workstation 050747
-  Fixing kit 051362
-  Manuspot 050679 (p.11)
-  Levelling bar 050693 (p.10)
-  Scissoring bar 050716 (p.10)
-  Double pads support 050723 (p.10)
-  Levelling lever 050686 (p.10)
-  Strengthened bar 1,2m 051171 (p.10)
-  052451 (p.10)
-  4 gripping multihook head 049758 (p.10)
-  6 gripping multihook head 049734 (p.10)
-  8 gripping multihook head 049741 (p.10)
-  3 lifting rods 050792 (p.12)
-  Dent box consumables 051515 (p.13)
-  Magnetic earth 049666 (p.12)

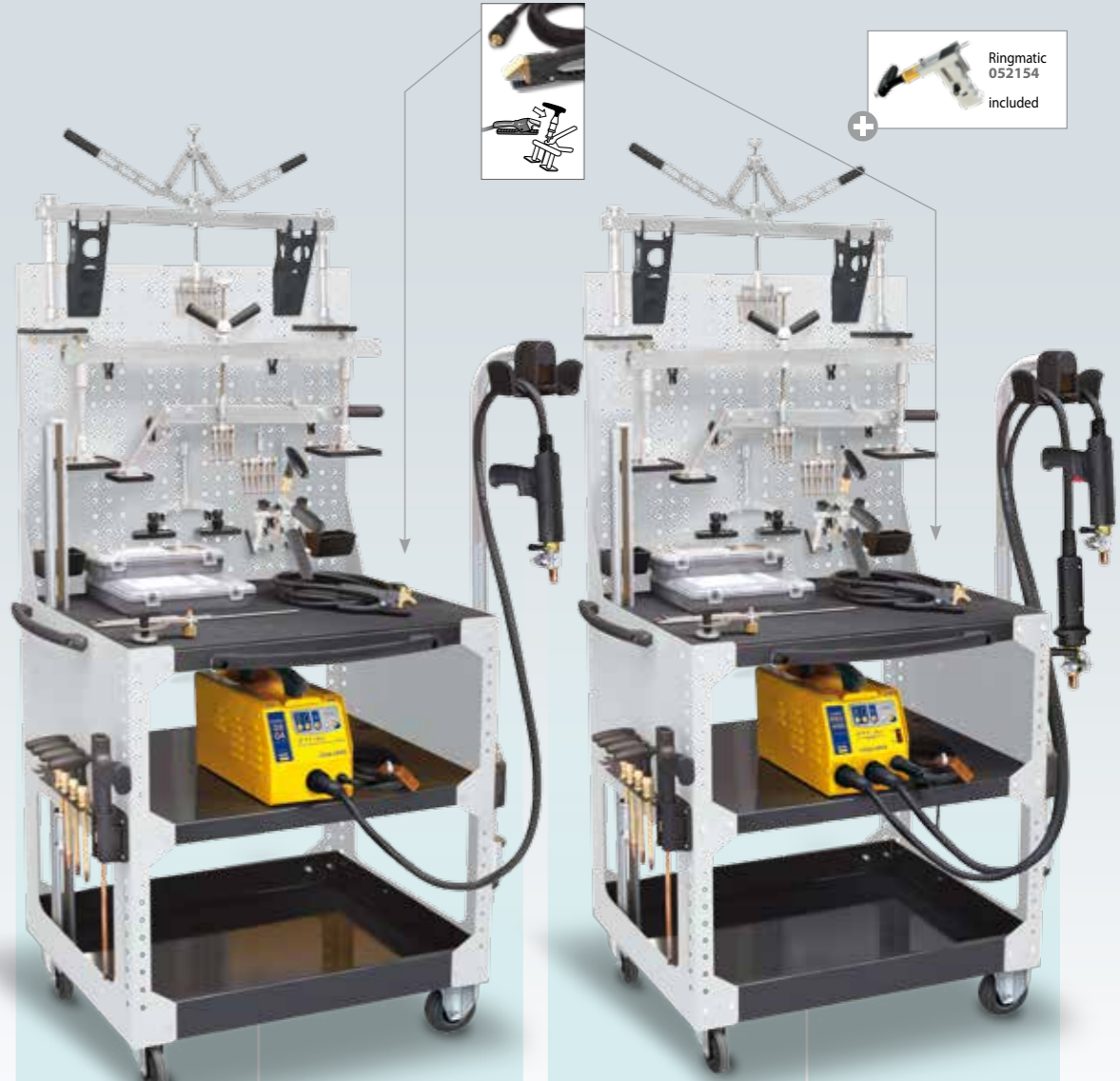

Ringmatic
052154
included



GYSPOT 39.02



GYSPOT 39.04



GYSPOT PRO 230



GYSPOT PRO 400



GYSPOT 39.02



GYSPOT 39.04



GYSPOT PRO 230



GYSPOT PRO 400

SPEEDLINER
(without generator)
035058

GYSLINER
(without generator)
035133

MARTEAUX ALU
- Alu hammers

020986

ALU



ALU PULLER

051003

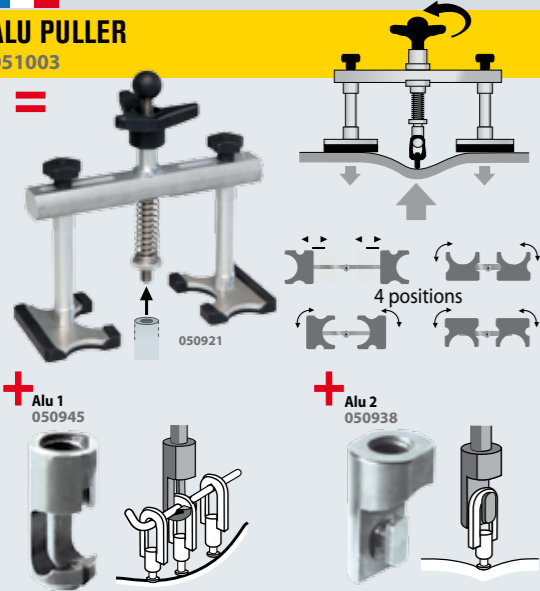

ANNEAUX DE TIRAGE RAPIDE

- Fast pulling rings - Aufsteckzugöse selbstarretierend

058743

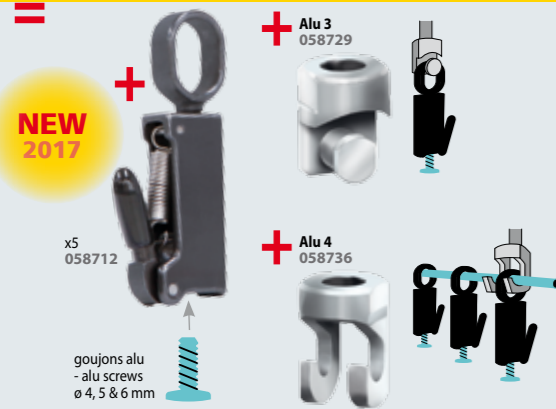

ASPIRATEUR PNEUMATIQUE POUR POUSSIÈRES ALUMINIUM (ATEX) - Pneumatic aluminium dust atex vacuum cleaner

058866

NEW 2017

Dust container capacity : 25 l
Working compressed air pressure : 6 bar
Compressed air consumption at 6 bar : 800 l/min
Suction connection diameter size : 50 mm
Max suction capacity : 150 m³/h
Max vacuum level : 2000 mm H₂O
Recommended compressor power : 7.5 HP

↳ 74 x 45 x 45 mm
▲ 18 kg



included
Filtre - Filter
058873

included
Sac à poussières
- Filter bag
Capacity 5 kg
058880

Housse de protection
- Protection cover
- Schutzhaube
048881



Marteau à inertie - Inertia hammer - Auszieh-hammer



380 g
050051

Lampe à souder - Blow torch - Lötlampe

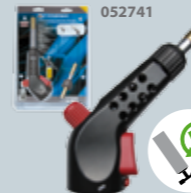

052741

Novacet +
(Butane/propane/
propylene)
380 ml/220 g
040441



Brosses - Brushes
- Bürsten - Brossen
- Cepillos



Inox
- Stainless -
Edelstahl
044258

Crayon marqueur thermique
- Thermal marking pencil



052765

121°C / 250°F

Thermomètre infrarouge
- Infrared Thermometer
- Infrarot Thermometer



052994

-50 / +380°C
-58 / +716°F

Spray refroidisseur
- Freezer spray



-50 °C
400 ml
(x 12)
048898

Gel barrière thermique
- Heat barrier
spray



054325



Alu
PROLINER
ALU PRO FV

035836



GYSPT ALU PRO FV



Trolley SPOT 800 051331



Alu puller 051003



Cable support 052284



GYSPT ALU PRO FV



Trolley SPOT 1600 051348



Alu puller 051003

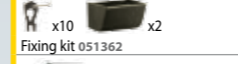

Fixing kit 051362

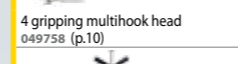

4 gripping multihook head
049758 (p.10)



Levelling bar 050693 (p.10)

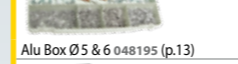

Alu Box Ø5 & 6 048195 (p.13)



Alu hammers 020986



Set of pencil punches with 6 teflon
tips 052888 (p.29)



Mini disc sander 051829 (p.70)



051423 (p.66)



Infrared Thermometer 052994



Thermal marking pencil 052765



Alu
SPEEDLINER
ALU PRO FV

036055





Acier/Steel/Stahl **+** Alu
SPEEDLINER COMBI 230 E.PRO
 036062

Complete solution



Ringmatic 052154 included

GYSPT COMBI 230 E.PRO	Trolley SPOT 1600 051348
Manuspot 050679 (p.11)	
4 gripping multihook head 049758 (p.10)	6 gripping multihook head 049734 (p.10)
Levelling bar 050693 (p.10)	Levelling lever 050686 (p.10)
Ringmatic (p.11) 052154	
3 lifting rods 050792 (p.12)	
052451 (p.10)	Magnetic earth 049666 (p.12)
Dent box consumables 051515 (p.13)	
Spotter box pro 050075 (p.13)	

+
 Alu puller 051003 (p.18)
 Alu box standard 050020 (p.13)
 Cable support 052284

GYSPT COMBI 230 E.PRO	Workstation 050747
Manuspot 050679 (p.10)	
x10 x2 Fixing kit 051362	
4 gripping multihook head 049758 (p.10)	6 gripping multihook head 049734 (p.10)
8 gripping multihook head 049741 (p.10)	Double pads support 050723 (p.10)
Levelling bar 050693 (p.10)	Levelling lever 050686 (p.10)
Ringmatic (p.10) 052154	Scissoring bar 050716 (p.10)
Strengthened bar 1,2m 051171 (p.10)	
3 lifting rods 050792 (p.12)	
052451 (p.10)	Magnetic earth 049666 (p.12)
Dent box consumables 051515 (p.13)	
Spotter box pro 050075 (p.13)	

+
 Alu puller 051003 (p.18)
 Alu box standard 050020 (p.13)
 Cable support 052284

Acier/Steel/Stahl **+** Alu
GYSLINER COMBI 230 E.PRO
 036079

Expert solution



Ringmatic 052154 included



OPTION
 QUICK SPOT AIR GUN (p.11) 052352

Housse de protection - Protection cover - Schutzhaube 048881

Acier/Steel/Stahl
DENTSTATION
PRO 230 (230 V) **PRO 400 (400 V)**
 036420 036437

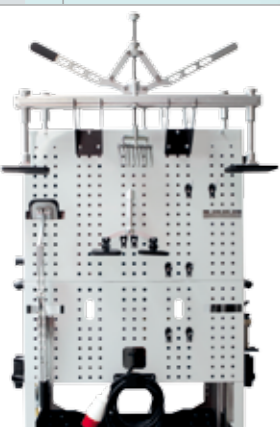







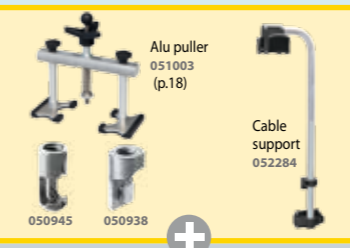
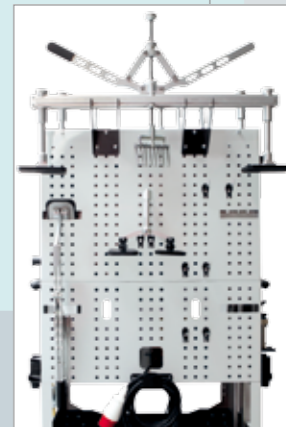



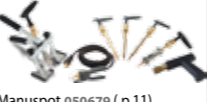

GYSOT PRO 230

GYSOT PRO 400

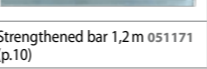
Acier/Steel/Stahl + Alu
DENTSTATION
COMBI 230 E.PRO
 036444

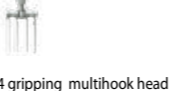

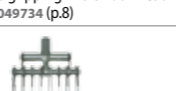
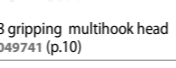
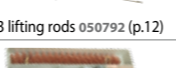
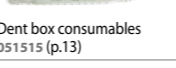
-  Dentstation Pro 056848
-  x10 x2
Fixing kit 051362
-  Manuspot 050679 (p.11)
-  Ringmatic 052154 (p.11)
-  Manual pulling handle 057289 (p.11)
-  Levelling bar 050693 (p.10)
-  Scissoring bar 050716 (p.10)
-  Double pads support 050723 (p.10)
-  Levelling lever 050686 (p.10)
-  Strengthened bar 1,2m 051171 (p.10)
-  052451 (p.10)
-  4 gripping multihook head 049758 (p.10)
-  6 gripping multihook head 049734 (p.8)
-  8 gripping multihook head 049741 (p.10)
-  3 lifting rods 050792 (p.12)
-  Dent box consumables 051515 (p.13)
-  Magnetic earth 049666 (p.12)

-  Dentstation Pro 056848
-  x10 x2
Fixing kit 051362
-  Manuspot 050679 (p.11)
-  Ringmatic 052154 (p.11)
-  Manual pulling handle 057289 (p.11)
-  Levelling bar 050693 (p.10)
-  Scissoring bar 050716 (p.10)
-  Double pads support 050723 (p.10)
-  Levelling lever 050686 (p.10)
-  Strengthened bar 1,2m 051171 (p.10)
-  052451 (p.10)
-  4 gripping multihook head 049758 (p.10)
-  6 gripping multihook head 049734 (p.8)
-  8 gripping multihook head 049741 (p.10)
-  3 lifting rods 050792 (p.12)
-  Dent box consumables 051515 (p.13)
-  Magnetic earth 049666 (p.12)

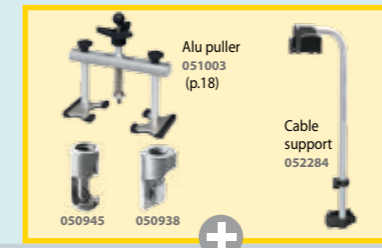

050945 050938

GYSOT COMBI 230 E.PRO

ÉQUERRE DE TIRAGE

- Draw aligner - Schnellausbeul-Richtausleger

052475

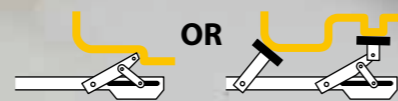
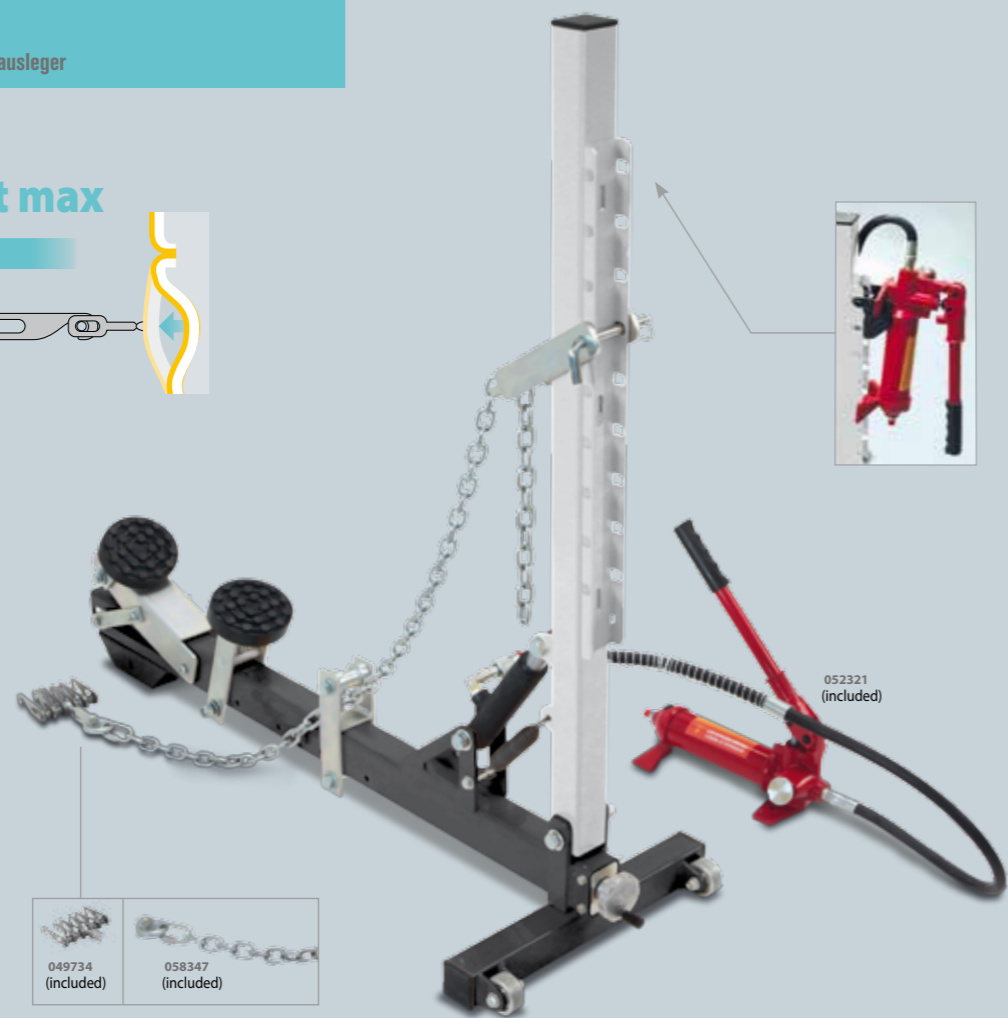
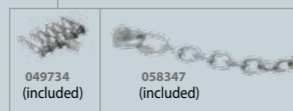
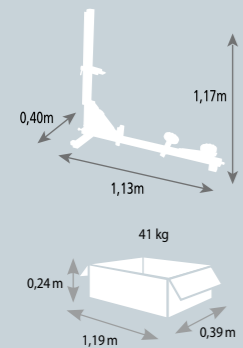
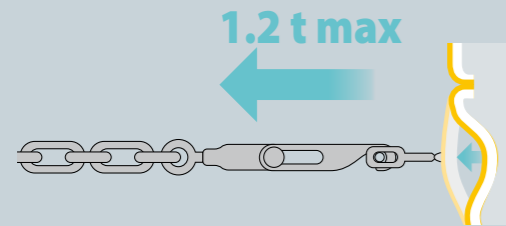

OPTION
Bras de bas de caisse
- Rocker panel arms
for draw aligner
- Abstütztraverse
für Richtausleger

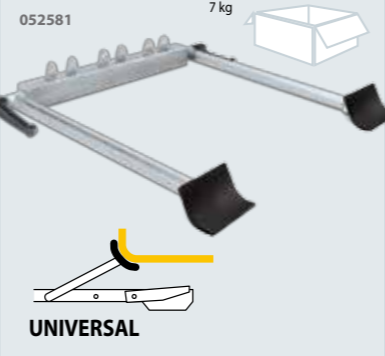

UNIVERSAL

SYSTÈME DE TIRAGE SMART PULLER SILVER

- Smart puller silver pulling system - Schnellausbeul-Richtausleger Smart puller silver

054820

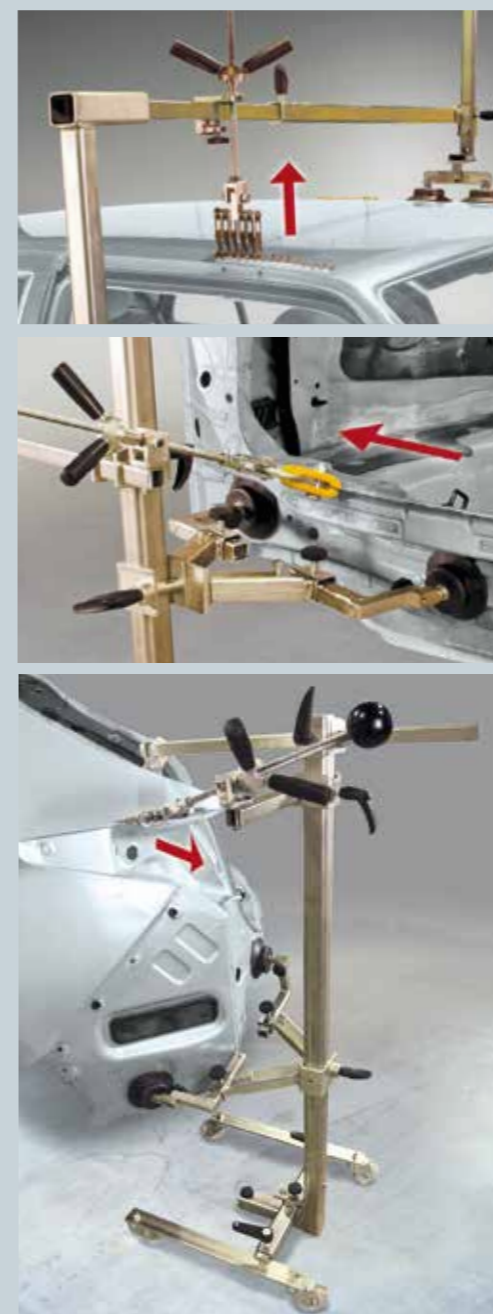

- Portières - Doors - Türen
- Montants - Supports - Scheibenrahmen
- Capot - Hood/Bonnet - Haube
- Armature - Armature - Rahmen
- Bas de caisse - Rocker panel - Schweller
- Ailes - Wings - Kotflügel
- Toit - Roof - Dach
- Hayon - Hatchback - Heckdeckel

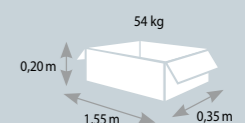
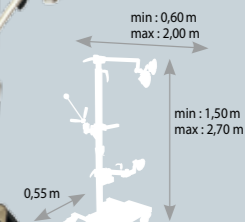

INCLUDED
Accessories

Autorobot

Spreading / Estensione

Pressing / Compressione

Pulling / Tiro

Pushing / Spinta

Applications / Applicazioni

ELECTRO POWER

with accessories:
057425

- PULLING POWER: 5 Ton.
- PUSHING POWER: 5 Ton.
- PISTON STROKE: 130 mm

MADE IN ITALIA

INCLUDED

Standard kit : 425x620x210 mm
Standard kit Total weight: 18 Kg
057401

Li-Ion battery (included)
058514

Accessories kit : 425x620x150 mm
Accessories kit Total weight: 20 Kg
057418

SATELLITE INTELLIGENT - Smart Satellite - Satellite Komplett-Kit

The best from **Autorobot**
www.autorobot.com/pdf/714B_ENG.pdf
MADE IN FINLAND



PACK SATELLITE

= 1 + 2 + 3 + 4 + 5 + 6
052727



<p>1 SATELLITE - Satellite - Satellite Basisbügel-Set 052710</p>		<p>2 KIT MAC PHERSON (A) - Mac Pherson Kit - Befestigungs- Federbein (McPherson) 052703</p>	
<p>3 BARRE POUR TIRER/POUSSER - Push/Pull Bar - Zug/Druck-Stangenset 052673</p>		<p>4 SATELLITE (B) - Bügelverlängerung 052680</p>	
<p>5 SANGLE DE SÉCURITÉ - Safety Strap - Sicherungsgurt 044036</p>		<p>6 DOUBLE PINCE SATELLITE (C) - Double Clamp Satellite - Satellite Doppelklemme 052697</p>	

PINCE DE TIRAGE MULTI-USAGE
- Versatile pulling clamp
- Multifunktions-Zugklemme
053571

KIT MARTEAU À INERTIE - Inertia hammer kit - Ausziehhammer kit
051928

6 kg

OUTILS DE TIRAGE - Frame Straightening - Ziehwerkzeuge

<p>Kit crochet de tirage « boomerang » - Boomerang pulling hook set - Zughaken Set «Boomerang» 052659</p>	<p>Pince de tirage à angle droit - Right angle pull clamp - Zugklemme 90° Winkel 052666</p>	<p>Pince de tirage à blocage automatique - Self-locking pull clamp - Selbstklemmende Zugklemme 052642</p>	<p>Mini pince de tirage à blocage manuel - Manual-locking pull clamp - Mini Klemme von Auflage in Handblockieren 056855</p>
---	---	---	---

COFFRET VÉRIN HYDRAULIQUE - Hydraulic cylinder kit - Hydraulischer Drucksatz

MADE IN P.R.C.

<p>BASIC 4T 052345</p>	<p>BASIC 10T 052338</p>
<p>PRO 4T 057432</p> <p>NEW 2017</p>	<p>PRO 10T 057449</p> <p>NEW 2017</p>

BARRE D'ANCRAGE - Anchor bar - Türspanner MADE IN TAIWAN

910 > 1130mm
053045

1540 > 1930mm
053052

MESURES - Measuring tools - Vermessung
GYSMETER, Electronic measurements
052093

Light weight measuring arm with an easy to read digital display

Measuring report

RAIL SAVER 052970

MADE IN HIGH QUALITY USA

700 mm

052321 (included)

BODYMETER, Mechanical Measurements
052130

400 > 2650 mm

250 > 2230 mm

INDUCTEUR DÉBOSELAGE - Dent Pulling Inductor - Ausbeul Induktor

Débosselage rapide et sans peinture
- Fast paintless dent pulling
- Lackschadenfreies Ausbeulen

GYSDUCTION AUTO DENT REPAIR 054981



Dent pulling inductor 054776



←	→	↕	Freq.	INTEGRATED TECHNOLOGY	❄️	Cable (m)	↕	👤		
50 Hz	A	W	kHz	PFC	FV	Liquid Cooling	Inductor	cm	kg	
230V, 1~	16	2.400	35+120	▪	▪	—	2	2,5	22 x 36 x 27	7,2

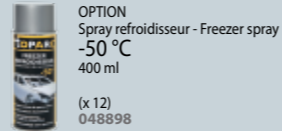

GLUE PULLER (Acier/Alu • Steel/Alu)



Glue Puller 050990

Mini Puller 050921

Glue Puller PRO 058699

Glue Lifter 057364



BARRETTES ANNEAUX PLASTIQUE - Plastic Multipads Ösen-Klebe pads

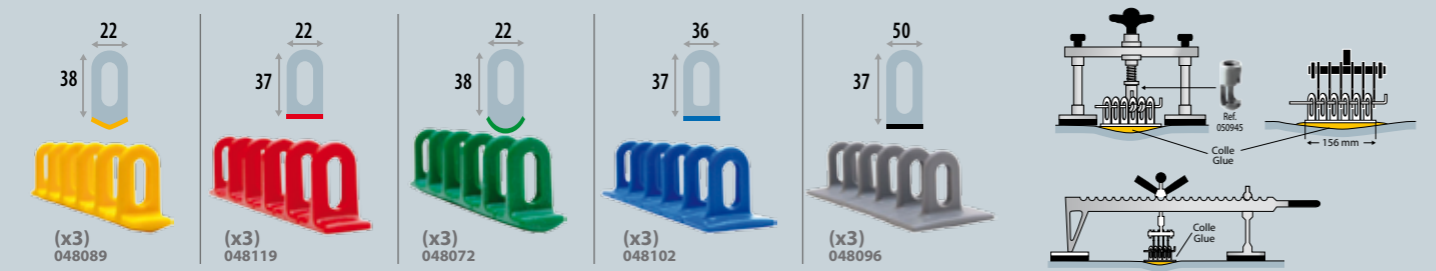

OPTIONS

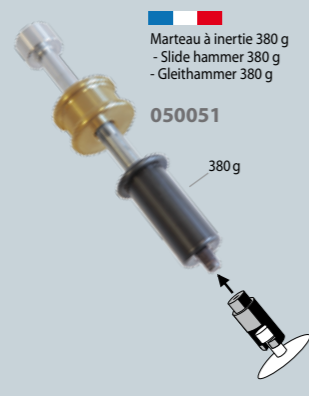
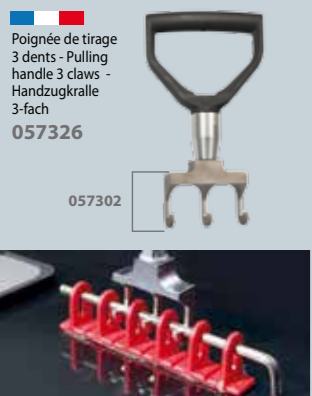

KIT MAGNÉTIQUE DE DÉBOSELAGE SANS PEINTURE - Paintless Dent Repair magnetic kit - Magnetisches Ausbeul-Kit

053168

EXELTOOLS

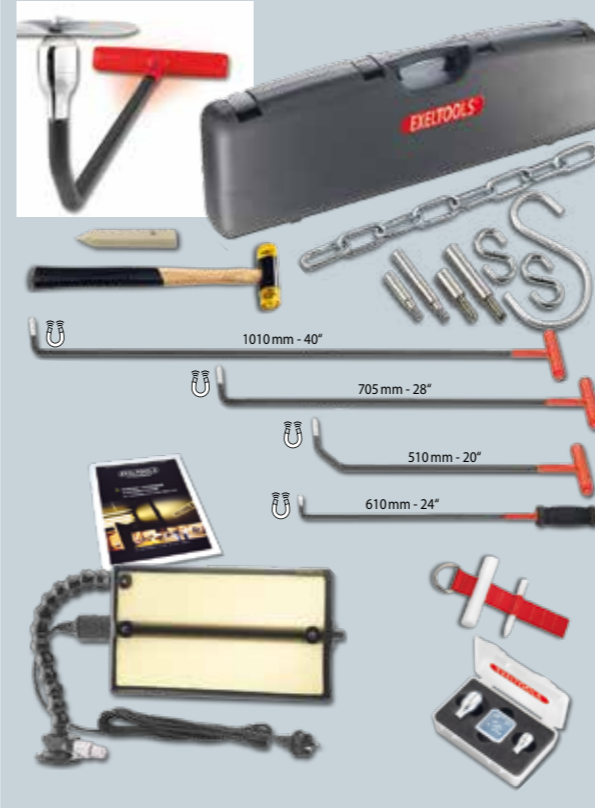

LAMPES DE DÉBOSELAGE - Paintless Dent Repair lamps - Ausbeullampe

056749

Made in Taiwan

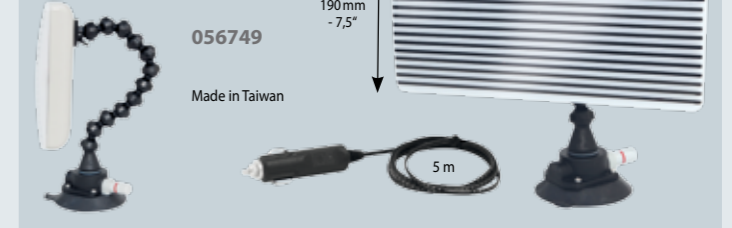

ULTRA LIGHT CARBON X40 PW - Paintless Dent Repair lamp - Ausbeullampe

053175

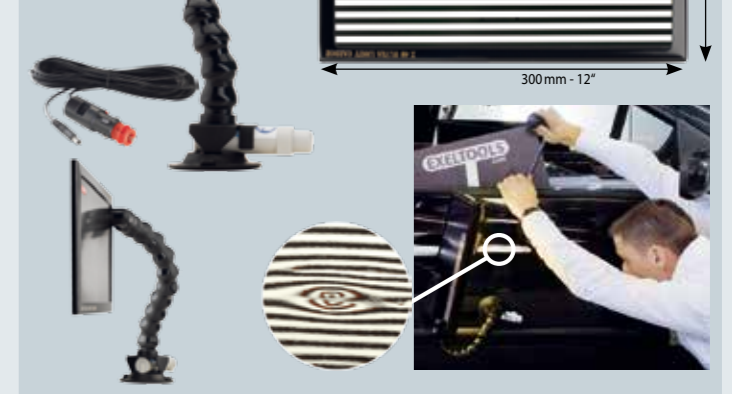

KIT DÉBOSELAGE SANS PEINTURE - Dent Pulling Kit (paintless) - Dellenausbeulhebel-Set

- Dent Pulling Kit (paintless) - Dellenausbeulhebel-Set



33 parts



KIT DE 6 COINS DE FRAPPE - Set of 6 pencil punches - Beulenstemmer-Satz mit 6 Tefloneinsätzen

- Set of 6 pencil punches - Beulenstemmer-Satz mit 6 Tefloneinsätzen



MARTEAU INERTIE PNEUMATIQUE - Pneumatic inertia hammer - Unterdruck-Schlaghammer



MARTEAU À INERTIE À VENTOUSES (POMPAGE MANUEL) - PUMP AIR SUCTION SLIDE HAMMER - Man. Unterdruck-Schlaghammer





SPOT LIFT

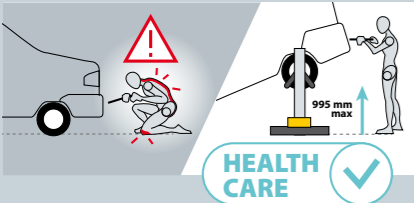
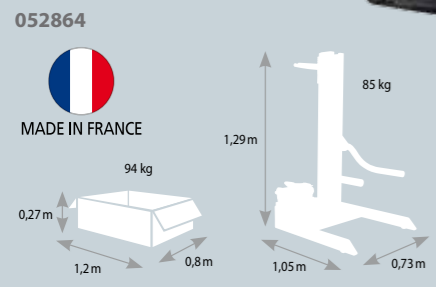

2,5t max

Haute stabilité - High stability

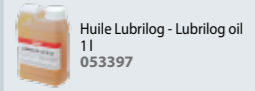
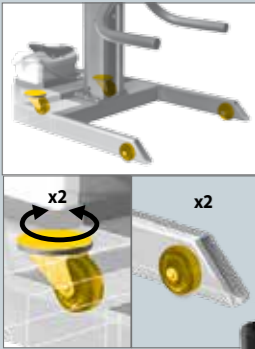

OPTION
Outil de levage pour bas de caisse
- Rocker panel lifting tool
- Auflage für Seitenschweller



Included
220 bar
053588

SPOT LIFT PRO

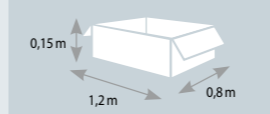
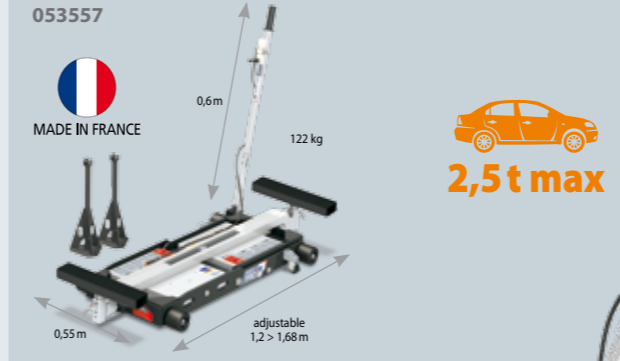

60 cm max
14 cm min



OPTION SPOT LIFT PRO
Réhausseur pour 4x4 et utilitaires
- Height adjuster for 4x4 & utility vehicles
- Erhöhung f. 4x4 und Leicht-LKW

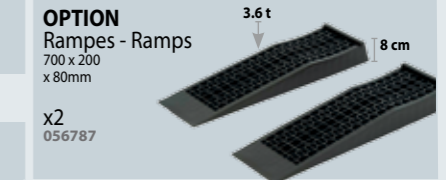

OPTION
Rampes - Ramps
700 x 200
x 80mm
x2
056787

SPOT LIFT PRO MOB

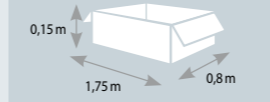
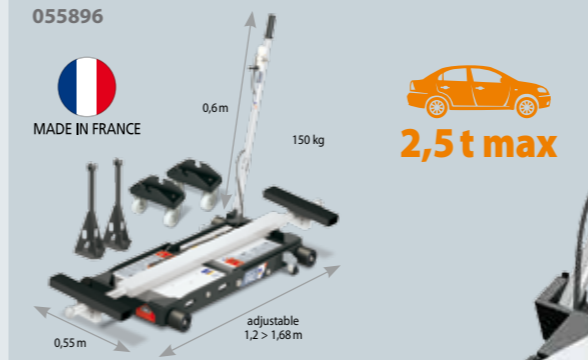

60 cm max
14 cm (min)



360°



CHARIOT DE MANUTENTION PRISE SOUS ROUE



AIR JACK



TABOURETS DE MANUTENTION

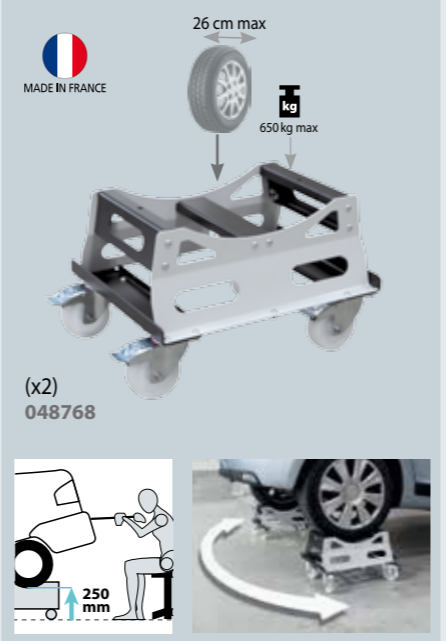

ÉVOLUTION TECHNOLOGIQUE

TECHNICAL IMPROVEMENTS - TECHNISCHE ENTWICKLUNG - MEJORAS TECNICAS

- | | | | |
|--|---|--|--|
| <p>France</p> <p>Facteurs d'évolution :</p> <ul style="list-style-type: none"> • Challenge CO2 = faible poids • Crash test = ★★★★★ • Anti corrosion = nouveaux revêtements • Esthétique et visibilité plus sophistiquées. | <p>UK</p> <p>Evolution factors :</p> <ul style="list-style-type: none"> • CO2 Challenge = low weight • Crash test = ★★★★★ • Anti-corrosion = new coatings • Improved aesthetics and demand for better occupant visibility. | <p>Germany</p> <p>Entwicklungsfaktoren :</p> <ul style="list-style-type: none"> • CO2 Challenge = geringes Gewicht • Crash-Test = ★★★★★ • Anti-Korrosion = neue Beschichtung • Modernes Technik-Design. | <p>Spain</p> <p>Factores de evolución :</p> <ul style="list-style-type: none"> • Challenge CO2 = peso débil • Ensayo de choque = ★★★★★ • Anti-corrosión = nuevos revestimientos • Diseño y visibilidad mas sofisticadas |
|--|---|--|--|

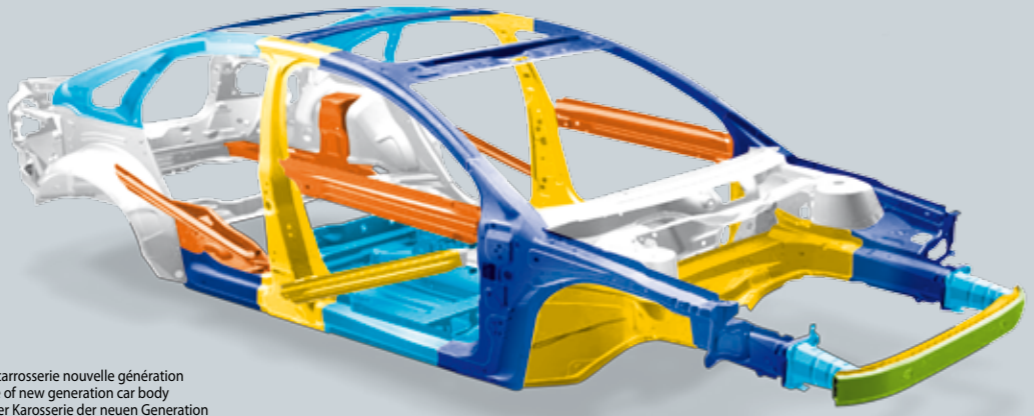
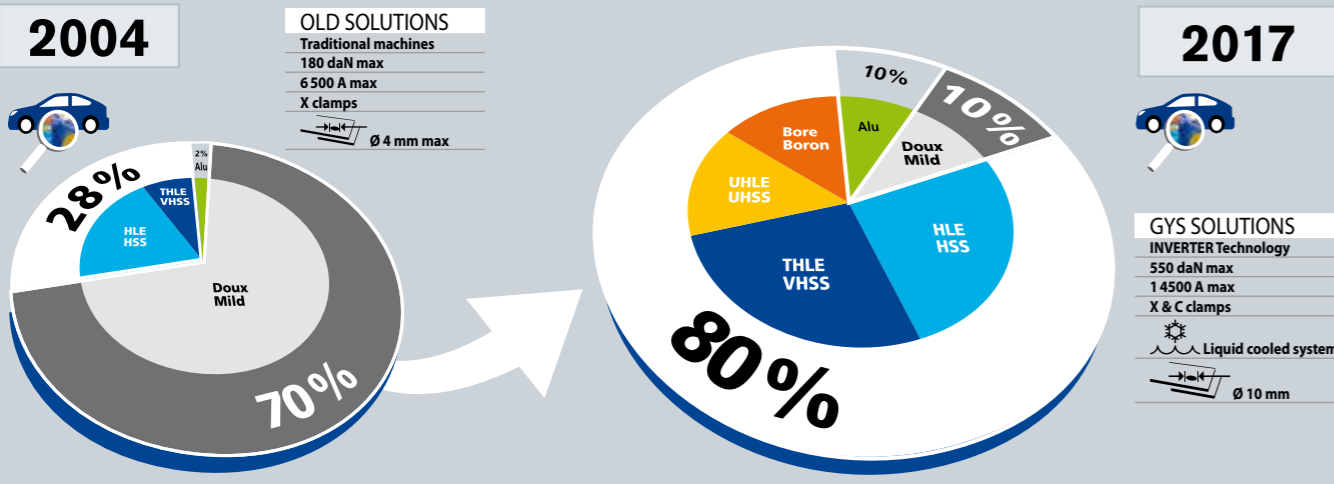

Exemple de carrosserie nouvelle génération
 • An example of new generation car body
 • Beispiel einer Karosserie der neuen Generation
 • Ejemplo de la nueva generacion de carrocerias

HOMOLOGATIONS PRODUITS

MANUFACTURER APPROVALS / COMPLIANCE - PRODUKT HOMOLOGATIONEN - PRODUCTOS HOMOLOGADOS

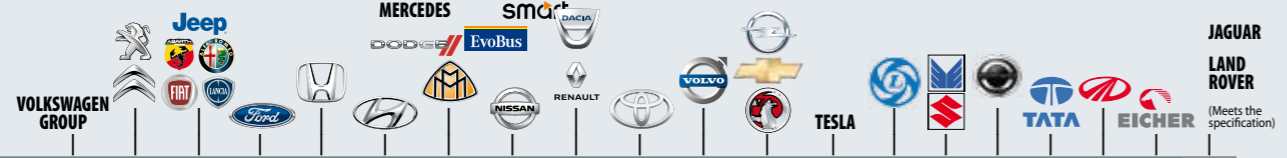

Product	VW	Jeep	Mercedes	Smart	Dodge	EvoBus	Renault	Nissan	Toyota	Volvo	Chevrolet	Tesla	Suzuki	Tata	Eicher	Jaguar	Land Rover
DENT PULLER																	
RESISTANCE SPOT WELDERS																	
MIG / MAG																	
PLASMA																	
INDUCED																	



RANGE



	32 D	100 R	BP-s7	EVOLUTION PTI-s7
Doux - Mild	< 2,0 mm	•	•	•
HLE/THLE - HSS/VHSS	< 2,0 mm	•	•	•
UHLE/BORE - UHSS/BORON	< 2,0 mm	•	•	•
Number of points (non stop : 10 points/min)	25	30	2000	2000
Number of spots (non stop : 10 spots/min)	7	10	120	120
Inverter Technology	—	•	•	•
EMF Directive 2013/35/UE	—	—	BODY PROTECT TECHNOLOGY	•
Cooling system	AIR	AIR	LIQUID	LIQUID
Automated regulation	irregular	constant	constant	constant
MODE AUTO	—	—	• (LC, LQC, LCX)	•
Pince - Clamp	• (32DX) • (32DC) • (X+C)	• (100R-X) • (100R-C) • (100R-CX)	• (BP.LX) • (BP.LC) • (BP.LCX)	•
Transformer Inside Clamp	—	—	—	•
Cables (L)	2,5 m	2,5 m	2,5 m	4 or 6 m
Includes gun	•	•	•	option
Fuse	32 A	32 A	32 A	25 A (14 500 A) 16A (11500 A)

BP BODYPROTECT TECHNOLOGY 2013/35/UE

UNIQUE ELECTRO-MAGNETIC FIELD PROTECTION by GYS

®BODY PROTECT is a proprietary GYS technology that minimises electromagnetic fields created by the machine.

Compliant : Directive 2013/35/UE
 Certified by : Laboratory EMITECH

MADE IN FRANCE

LA SOLUTION GLOBALE - THE GLOBAL SOLUTION

Other technologies	GYS BODYPROTECT TECHNOLOGY
B1: 10 < 25 cm (Norm : 3 cm max)	B1: 0 cm (Norm : 3 cm max)
B2: 25 < 35 cm (Norm : 30 cm max)	B2: 5 cm (Norm : 30 cm max) / 4 cm (Norm : 30 cm max)
B3: 35 cm (Norm : 20 cm max)	B3: 0 cm (Norm : 20 cm max)
B4: 35 cm (Norm : 20 cm max)	B4: 0 cm (Norm : 20 cm max)

PORTASPOT 230

6 300 A 120 daN

Air cooled

230V
022256



DELIVERED WITH PX 1



ARMS Ø 25 mm

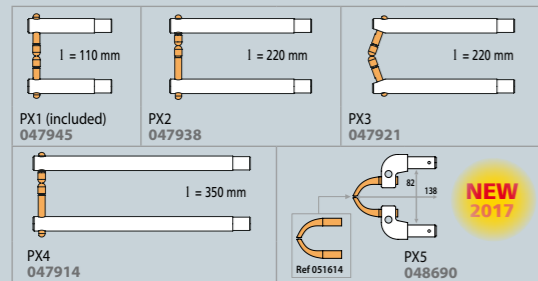

ELECTRODES

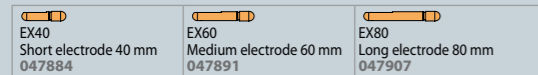

CAPS & ACCESSORIES



50/60 Hz	1 x 230V	AM	RMS	MAX	mm	Uo	Cable	100% CU	(no arm) cm	kg
		A	A	A	2+2	2,45	3x2,5 H05VVE	OK	36x29 x10	10

GYSPOT 32D-X

7 500 A 500 daN

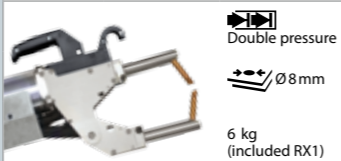

Air cooled

2 x 400V
022850
complete : 019881

GYSPOT 32D-C

7 500 A 300 daN

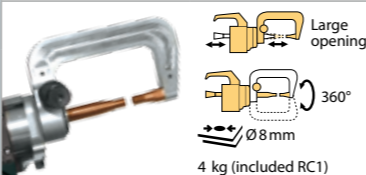

Air cooled

2 x 400V
019898



GYSPOT INVERTER 100R-X

10 000 A 500 daN

For mild steel, HSS, UHSS



Air cooled

Traceability software
Save spot welding configuration and export data

3 x 400V
019911



GYSPOT INVERTER 100R-C

10 000 A 300 daN

For mild steel, HSS, UHSS

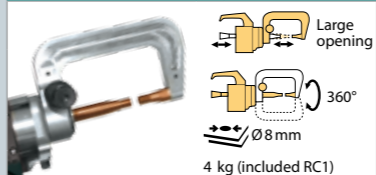

Air cooled

Traceability software
Save spot welding configuration and export data

3 x 400V
019928



GYSPOT INVERTER 100R-CX

10 000 A 500 daN (X)
300 daN (C)

For mild steel, HSS, UHSS

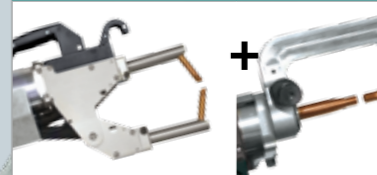

Air cooled

Traceability software
Save spot welding configuration and export data

3 x 400V
022317



OPTIONS



INCLUDED

	022850	022867	019881	019898	019911	019928	022317
32D-X	■	■	■	■	■	■	■
OPTIONAL PACKAGE 32D-X	■	■	■	■	■	■	■
32D-X complete	■	■	■	■	■	■	■
32D-C	■	■	■	■	■	■	■
100R-X	■	■	■	■	■	■	■
100R-C	■	■	■	■	■	■	■
100R-CX	■	■	■	■	■	■	■

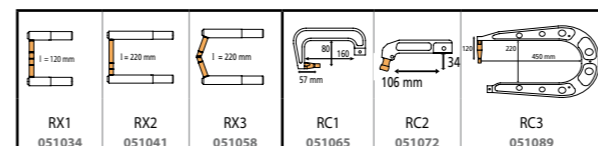

MADE IN FRANCE 60974/1	50/60 Hz	AM	RMS	MAX	mm	Uo	Cables		100% CU	cm	kg
							Air Cooled	mm²			
GYSPOT 32D.X GYSPOT 32D.C	2 x 400V	32 (D)	7 500	10 500	3 + 3	1,2 + 3	2,2	200	OK	55 x 75 x 190	100
							2,5	150			
GYSPOT 100R.X GYSPOT 100R.C GYSPOT 100R.CX	3 x 400V	32 (D)	10 000	—	3 + 3 + 3	1,5 + 3	2,5	200	OK	70 x 99 x 208	108
							2,5	150			
							8	4 x 6 H07RNF			125

INVERTER • AIR COOLED

GYSPT INVERTER BP-LX

13 000 A
550 daN

For mild steel, HSS, UHSS **Boron steel**

Double pressure
∅ 10 mm
6,5 kg (included X1)

Liquid cooled

BP BODYPROTECT
Unique electro-magnetic field protection by GYS

Traceability software
Save spot welding configuration and export data

NEW 2017



	019652	058804
	400V	
Monopoint/Spot 049291	▪	▪
Spotter box pro (p.13) 050075	▪	▪
Inertia hammer 049482 + 049802	▪	▪
	▪	▪
X1 050501	▪	▪
	▪	▪
X4A (x2) + X48 + X4C + X2 020733	▪	▪
	▪	(x3)
CORAGARD CS 330 (10) 052246		

GYSPT INVERTER BP-LC-s7

13 000 A
550 daN

For mild steel, HSS, UHSS **Boron steel**

Double pressure
∅ 10 mm
6,5 kg (included C1)

Liquid cooled

BP BODYPROTECT
Unique electro-magnetic field protection by GYS

EDC Automatic C clamp
Energy Dynamic Control

Traceability software
Save spot welding configuration and export data

NEW 2017



	020757	058798
	400V	
Monopoint/Spot 049291	▪	▪
Spotter box pro (p.13) 050075	▪	▪
Inertia hammer 049482 + 049802	▪	▪
Contact grease 050440	▪	▪
Caps remover 050846	▪	▪
	▪	▪
Arm panel 200 mm 019140	▪	▪
	▪	▪
C1 019140	▪	▪
	▪	▪
C2 + C3 + C4 019126	▪	▪
	▪	▪
C6 019775	▪	▪
	▪	(x3)
CORAGARD CS 330 (10) 052246		

Included
Support haute stabilité
-High stability support
Compatible gyro
+

OPTION



OPTIONS

	050068		x10 (x20: 052239)		x18 (x6: 049987)
	048935		x6 (x6: 049994)		x18 (x6: 049970)
	x40 (x6: 049987)				



CORAGARD CS 330 10l
Liquide de refroidissement
Cooling liquid
Kühlmittel
Enfriamento líquido
Refrigeración líquida
052246

Housse de protection
- Protection cover
- Schutzhaube
050853



MADE IN FRANCE	60974/1	50/60 Hz	A	A	V		100 % CU	cm	kg
GYSPT BPLX		3 x 400V	32 (D)	13000	16		OK	65 x 80 x 205	160
GYSPT BPLC-s7									

GYSPT INVERTER BP-LQC-s7

13 000 A
550 daN

For mild steel, HSS, UHSS **Boron steel**



Liquid cooled

BP BODYPROTECT
Unique electro-magnetic field protection by GYS

EDC Automatic C clamp
Energy Dynamic Control

Traceability software
Save spot welding configuration and export data

	NEW 2017 022713	021082	NEW 2017 058774
Gyspot BP-LQC-s7	220V	400V	
Monopoint/Spot 049291	▪	▪	▪
Spotter box pro (p.13) 050075	▪	▪	▪
Inertia hammer 049482 + 049802	▪	▪	▪
Caps remover 050846	▪	▪	▪
Arm panel	▪	▪	▪
QC1 021167	▪	▪	▪
QC2 + QC3 + QC4 022065	▪	▪	▪
CORAGARD CS 330 (10) 052246			(x3)



Included
Support haute stabilité
-High stability support
Compatible gyro
+ 🔒

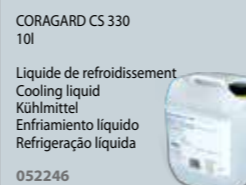

for : BP LQC **NEW GENERATION**

MADE IN FRANCE

550 daN **6,5 kg** including C1

LIQUID COOLED
REFROIDISSEMENT LIQUIDE ∅ 10 mm

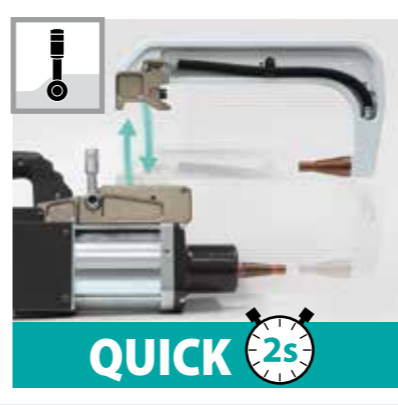
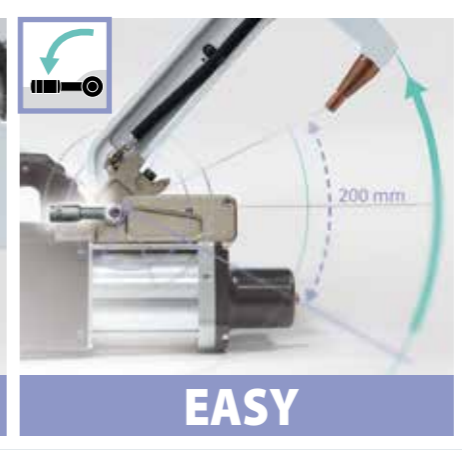
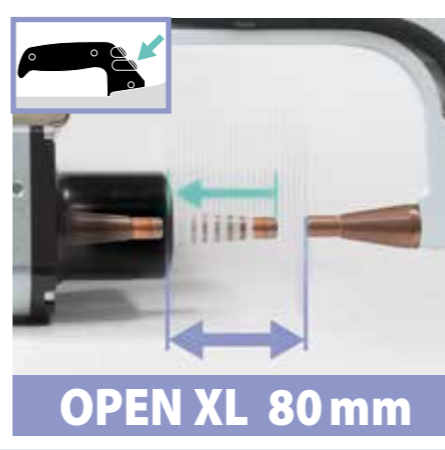

C Arms - Caps Ø13 mm
Bras isolés - Isolated arms - Isolierte Bügel

= Aluminium nickelé - Nickel plated aluminium - Aluminium (vernickelt)

 QC1 8 bar/550 daN 021167	 QC4 8 bar/550 daN 021228	 QC6 8 bar/550 daN 021259	 QC5 4 bar/150 daN 021235
 QC3 8 bar/300 daN 021204	 QC2 8 bar/550 daN 021181	 QC7 8 bar/550 daN 022072	 QC8 8 bar/550 daN 022751

Arm panel
QC2 + QC3 + QC4 022065

GYSPT BP.LQC-s7	50/60 Hz	+AM+	RMS	Uo	mm	Cables				100% CU	cm	kg
						2,5 m, ∅ 200 mm ² , Liquid	2,5 m, ∅ 150 mm ² , air	8 m, 4x6 H07RN-F (BP 220V: 4x6AWG)	OK			
3 x 400V	32 (D)	13 000	16	3 + 3 + 3	1,5 + 3	2,5 m, ∅ 200 mm ² , Liquid	2,5 m, ∅ 150 mm ² , air	8 m, 4x6 H07RN-F (BP 220V: 4x6AWG)	OK	65 x 80 x 205	160	
3 x 208-220-240	63 (D)	10 500 11 000 12 000 12 500	15 15,5 17 18	3 + 3 + 3	1,5 + 3	2,5 m, ∅ 200 mm ² , Liquid	2,5 m, ∅ 150 mm ² , air	8 m, 4x6 H07RN-F (BP 220V: 4x6AWG)	OK	65 x 80 x 205	160	

INVERTER • LIQUID COOLED

GYSPT SPOT INVERTER BP-LCX-s7

13 000 A
550 daN

For mild steel, HSS, UHSS Boron steel

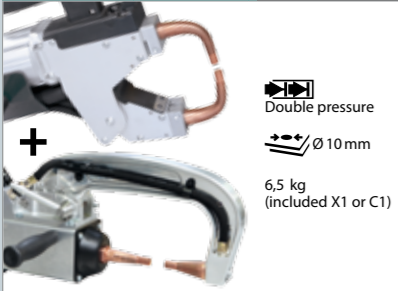

Double pressure
Ø 10 mm
6,5 kg
(included X1 or C1)

Liquid cooled

BP BODYPROTECT
Unique electro-magnetic field protection by GYS

EDC Automatic C clamp
Energy Dynamic Control

Traceability software
Save spot welding configuration and export data

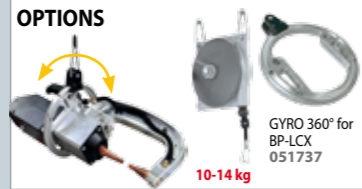

GYRO 360° for BP-LCX
051737
10-14 kg



Included
Support haute stabilité
-High stability support
Compatible gyro
+

OPTIONS

	CORAGARD CS 330 10l	Housse de protection - Protection cover - Schutzhaube for BP & PTI 050853			
	x10 (x20: 052239)		Liquide de refroidissement Cooling liquid Kühlmittel		
	x6 (x6: 049994)		Enfriamento líquido Refrigeración líquida		
	048935				

GYSPT SPOT INVERTER EVOLUTION PTI

14 500 A
550 daN

For mild steel, HSS, UHSS Boron steel



FUSE
16 > 25 A
Double pressure
Ø 10 mm
10,5 kg
(included C1)

TRANSFORMER INSIDE

Liquid cooled

EDC Automatic C clamp
Energy Dynamic Control

Traceability software
Save spot welding configuration and export data

NEW DESIGN

Very light
10,5 kg



High stability
Compatible gyro

OPTION

	gun supports
	1,80 m
	1m
	Complete gun kit 051010
	GYRO 360° for PTI 051720

	4M 022188	4M 020894	4M 058811
	6M 022195	6M 020900	

220V 400V

	Gyspot BP-LCX-s7			
	Contact grease 050440			
	Caps remover 050846			
	Arm panel 20 mm			
	C1 021402			
	C2 + C3 + C4 021457			
	C6 019775			
	Gyro 360° 051720			
	Complete gun kit 051010			
	CORAGARD CS 330 (10l) 052246			(x3)

MADE IN FRANCE 60974/1	50/60 Hz	A	RMS	Uo	mm	Cables			100% CU	cm	kg
						3+3+3	1,5+3	2,5 m, Ø 200 mm ² , liquid			
GYSPT BP.LCX-s7	3 x 400V	32 (D)	13 000	16	3+3+3	1,5+3	2,5 m, Ø 200 mm ² , liquid	8 m, 4x6 H07RNF (BP 220V: 4x6AWG)	OK	65 x 80 x 205	180
GYSPT BP.LCX-s7 220 V	3 x	200 208 220 240	10 500 11 000 12 000 12 500	15 15,5 17 18							
GYSPT EVOLUTION PTI-s7	3 x 400V	25 (D) 16 (D)	14 500 11 500	8	3+3+3	1,5+3	4 m, liquid 6 m, liquid	OPTION 051010: 1,5 m, Ø 200 mm ²	OK	65 x 80 x 230	100
GYSPT EVOLUTION PTI-s7 220 V	3 x	200 208 220 240	14 500 14 500 14 500 14 500	6,95 7,2 8 8,3			4 m, liquid 6 m, liquid	8 m, 4x4 H07RNF 8 m, 4xAWG8 (500W)	OK	65 x 80 x 230	100

for : 32DX • 100RX • 100RCX • BPLX • BPLCX

550 daN

6,5 kg including X1

- DOUBLE PRESSURE
- LIQUID COOLED REFRIGERATION LIQUIDE
- Ø 10 mm

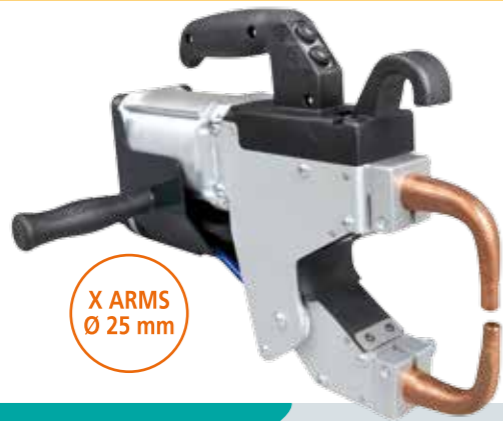

X ARMS Ø 25 mm

Remote control (BP)



Clamp control



X Arms - Caps Ø13 mm

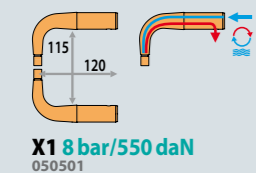

X1 8 bar/550 daN 050501

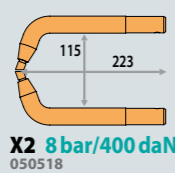

X2 8 bar/400 daN 050518

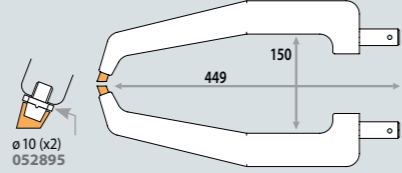

X4 8 bar/120 daN 050532

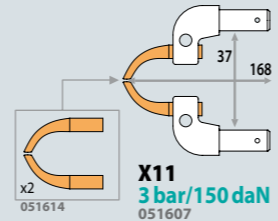

X11 3 bar/150 daN 051607

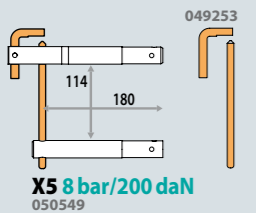

X5 8 bar/200 daN 050549

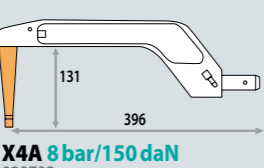

X4A 8 bar/150 daN 020702

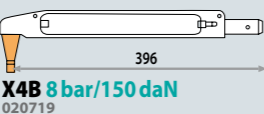

X4B 8 bar/150 daN 020719

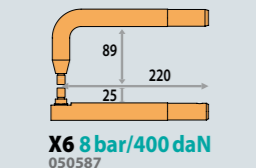

X6 8 bar/400 daN 050587

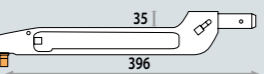

X4C 8 bar/150 daN 020726

X4 (A, B & C) combinations

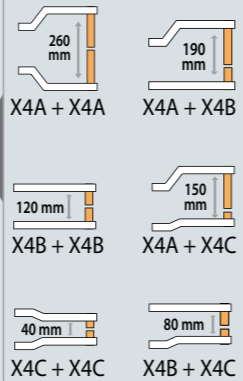

Arm panel

X4A (x2) + X5 + X2 022324

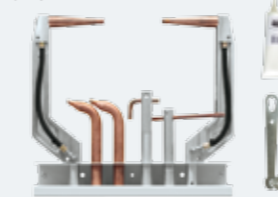

X4A (x2) + X4B + X4C + X2 020733

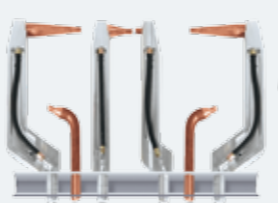

Consommables X & C - X & C Consumables

- Type A Cor X clamp Ø 13 mm (x6) 049987
- Type B Cor X clamp Ø 13 mm / Ø 5 mm (x6) 055506
- Type C X2, X4, C11 arms Ø 13 mm (x6) 049994
- Type D Cor X clamp Ø 13 mm (x10) 058507
- TYPE F For single sided gun Ø 13 mm (x6) 049970



Lame - Blade 052857



Affuteur de caps - Cap grinder 048966



GYRO 360°



10-14 kg for BPLC/BPLCX 051737

for EVOLUTION 051720

BANC DE TRACTION ARRACHE TÔLE - Steel sheet traction bench - Blech-Zugbank zur Festigkeitsprüfung



CAPEUR D'EFFORT - Electrode force sensor

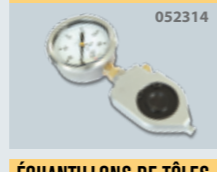

GYSTEEL VISION

IDENTIFIEZ VOTRE ACIER - STEEL IDENTIFICATION - IDENTIFIZIEREN SIE DIE STAHLHÄRTE

Register online test certificate

Acier/Steel 0,8 (x65) + 1 (x55) + 1,5 (x35) + 2 (x25) + Alu 1 (x45) + 1,5 (x30) + 2 (x20) 055841

BORE BORON

DOUX MILD HLE HSS UHLE UHSS

GYSTEEL VISION Result

ÉCHANTILLONS DE TÔLES - Sheets set

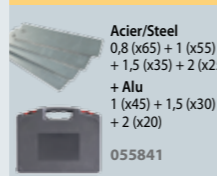

KIT DE PURGE RÉSERVOIR - Tank draining kit - Kit zur Tankentleerung



VALISE DE TEST SOUDURE - Weld test kit - Schweißtestkit im Hartschalenkoffer



for : EVOLUTION PTI • BPLCX • BPLC

550 daN

6,5 kg including C1

- DOUBLE PRESSURE
- LIQUID COOLED REFRIGERATION LIQUIDE
- Ø 10 mm



550 daN

Transformer inside

10,5 kg including C1

- DOUBLE PRESSURE
- AIR COOLED + LIQUID COOLED DOUBLE REFRIGERATION AIR + LIQUID
- Ø 10 mm

C Arms - Caps Ø13 mm

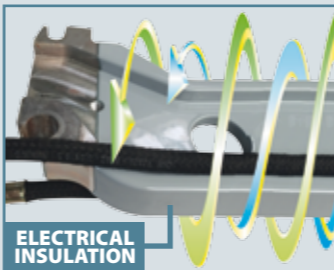

ELECTRICAL INSULATION

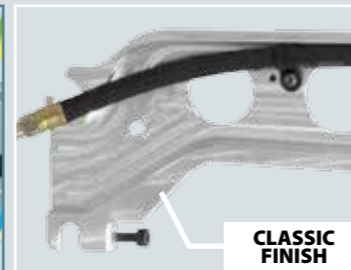

CLASSIC FINISH

Remote control (BP)



Change Mode & Parameters

Arm panel



C2 + C3 + C4 019126

C2 + C3 + C5 + C6 + C9 050044



C2 + C3 + C4 021457



Bras isolés - Isolated arms - Isolierte Bügel & Classic arms

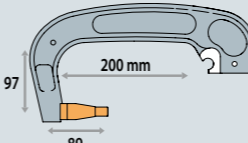

C1 8 bar/550 daN

021402 019140

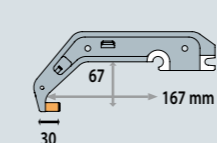

C5 8 bar/550 daN

022393 019294

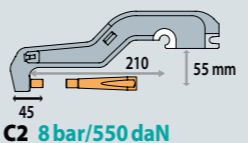

C2 8 bar/550 daN

022386 019133

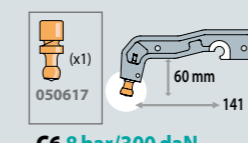

C6 8 bar/300 daN

022409 019775

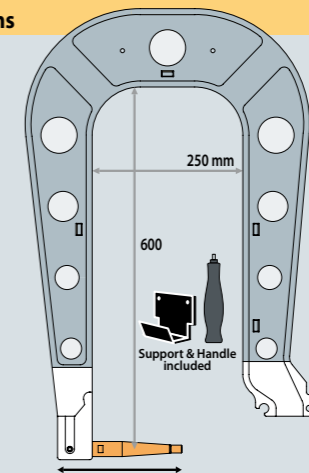

C9 8 bar/550 daN

020078



C3 8 bar/550 daN

021419 019157

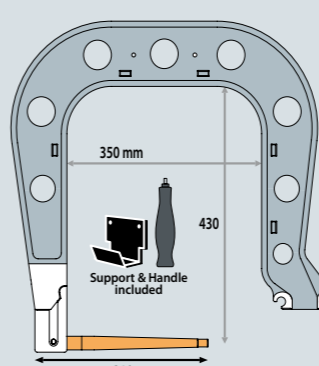

C7 8 bar/550 daN

021433 020009

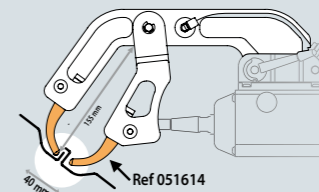

C10 4 bar/150 daN

051638

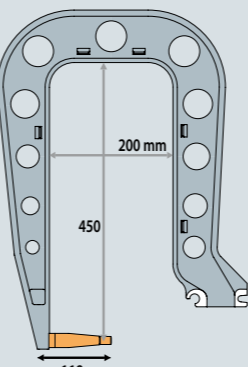

C4 8 bar/550 daN

021426 019164

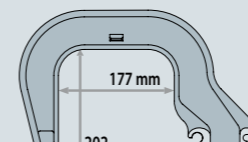

C8 8 bar/550 daN

021440 020016

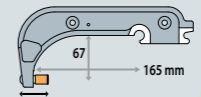

C12 8 bar/550 daN

022997 023000

NEW 2017

UNIVERSAL CAR BODY RIVETING SYSTEMS

8t PNEUMATIC HYDRAULIC

(7840 daN)



45

RIVETING SYSTEM

GYPRESS 8T

053861



INCLUDED

	Standard 8T tool box (2 clés + centreur inclus) (2 keys + special center punch included) 053694
	HR15 054219
	for HR15 & HR2 057111
	HR arm locker
	Strap - Sangle - Gurt
	Poignée - Handle - Griff
	6 x 50 rivets - Nieten RAP/SPR ACIER / STEEL / STAHL 048706 Ø 3,3 x 3,5 mm Ø 5,3 x 4,0 mm Ø 3,3 x 4,0 mm Ø 5,3 x 5,0 mm Ø 5,3 x 6,0 mm Ø 5,3 x 8,0 mm

Discover it on Youtube



CONTRÔLE DE LA PRESSION - Pressure control - Druckregelung



CONTRÔLE DE LA VITESSE - Speed control - Regelung Werkzeuggeschwindigkeit



DISCHARGE LEVER - Auslösehebel

Unique Push Pull system by GYS

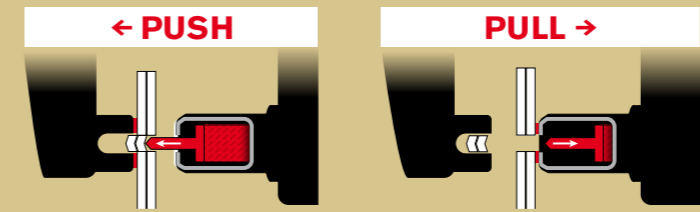

NEW 2017

GYPRESS 8T PUSH PULL

056893



INCLUDED

	Standard 8T PushPull tool box (2 clés + centreur inclus) (2 keys + special center punch included) 058361
	HR15 054219
	for HR15 & HR2 058644
	HR arm locker
	Strap - Sangle - Gurt
	Poignée - Handle - Griff
	6 x 50 rivets - Nieten RAP/SPR ACIER / STEEL / STAHL 048706 Ø 3,3 x 3,5 mm Ø 5,3 x 4,0 mm Ø 3,3 x 4,0 mm Ø 5,3 x 5,0 mm Ø 5,3 x 6,0 mm Ø 5,3 x 8,0 mm

CONTRÔLE DE LA PRESSION - Pressure control - Druckregelung



CONTRÔLE DE LA VITESSE - Speed control - Regelung Werkzeuggeschwindigkeit



SÉLECTION PUSH/PULL - Push/Pull selection

	AIR BAR	PRESSURE CONTROL	SPEED CONTROL	cm	kg	cm	kg
MADE IN FRANCE GYPRESS 8T	8 bar = 8 t (maxi 10 bar)	0 > 8 bar	+ -	38 x 140	5 (HR15 included)	58 x 48 x 15	10
GYPRESS 8T PUSH PULL	8 bar = 8 t (maxi 10 bar)	0 > 8 bar	+ -	39.5 x 18	5.8 (HR15 included)	58 x 48 x 15	10.8

KIT MATRICES - Dies tool box - Matrizen-Kit

<p>Pose de rivets auto-perçants - Application of self-piercing rivets - Stanzniet-Verpressen</p> <p>2.0 < 6.5 mm</p>	<p>Pose de rivets pleins - Application of solid rivets - Vollniet-Verpressen</p> <p>2.3 < 8.3 mm</p>	<p>Pose de rivets Flow-Form - Application of Flow-Form rivets - Setzen v. Fließformnieten</p> <p>2.3 < 8.3 mm</p>	<p>Extraction de rivets auto-perçants - Extraction of self-piercing rivets - Stanzniet-Auspressen</p> <p>2.3 < 8.3 mm</p>	<p>Perçage et formage des tôles pour rivets pleins - Metal sheet punching and shaping - Vollniet-Lochstanzen/Prägen</p> <p>2.3 < 8.3 mm</p>	<table border="1"> <tr> <th>Material</th> <th>Pressure Range (bar)</th> </tr> <tr> <td>RAP 0.3.3</td> <td>3 - 5.2</td> </tr> <tr> <td>RAP 0.5.3</td> <td>4.7 - 5.8</td> </tr> <tr> <td>RFF Alu 0.6</td> <td>5.3 - 6.4</td> </tr> <tr> <td>RFF Steel 0.6</td> <td>5.8 - 7</td> </tr> <tr> <td>RFF Steel 0.8</td> <td>6.5 - 8</td> </tr> </table> <p>Eject & Drilling</p>	Material	Pressure Range (bar)	RAP 0.3.3	3 - 5.2	RAP 0.5.3	4.7 - 5.8	RFF Alu 0.6	5.3 - 6.4	RFF Steel 0.6	5.8 - 7	RFF Steel 0.8	6.5 - 8
Material	Pressure Range (bar)																
RAP 0.3.3	3 - 5.2																
RAP 0.5.3	4.7 - 5.8																
RFF Alu 0.6	5.3 - 6.4																
RFF Steel 0.6	5.8 - 7																
RFF Steel 0.8	6.5 - 8																

STANDARD 8T

Included in GYSPRESS 8T 053694

MADE IN FRANCE

A1 055698	A2 055704	B1 055711	B2 055728	E1 055865 (x5) 054288	E2 055766
A1 + A2 set 054295		B1 + B2 set 054301		E1 + E2 set 054318	
F1 055773	F2 055780	D17 055681	D17 055681	Applanissement des tôles - Metal sheet levelling - Blech-Rückverformung	
F1 + F2 set 054714		D17 + D17 set 055681		clés plate x2 joints x4	
				T1 057098	T2 057104
Pointeau centreur - Special center punch - Spezialkörner 048379				T1 + T2 set 054707	

STANDARD 8T PUSH PULL

Included in GYSPRESS 8T Push Pull 058361

NEW 2017

MADE IN FRANCE

A1 055698	A2 055704	B1 055711	B2 055728	E1 055865 (x5) 054288	E2 055766
A1 + A2 set 054295		B1 + B2 set 054301		E1 + E2 set 054318	
F1 055773	F2 055780	D17 055681	D17 055681	Applanissement des tôles - Metal sheet levelling - Blech-Rückverformung	
F1 + F2 set 054714		D17 + D17 set 055681		clés plate x2 joints x4	
				T7 058033	ST1 058071
Pointeau centreur - Special center punch - Spezialkörner 048379				T7 + ST1 set 058033	
				T5 058019	

RMB 01

For BMW 054240

MADE IN FRANCE

A1 055698	A2 055704	B1 055711	B2 055728	E1 055865 (x5) 054288	E2 055766
A1 + A2 set 054295		B1 + B2 set 054301		E1 + E2 set 054318	
				clés plate x2 joint x4	

RMB 02

For Jaguar/Land Rover 054271

MADE IN FRANCE

B3 055735	B2 055728	E1 055865	E6 057142
		Applanissement des tôles - Metal sheet levelling - Blech-Rückverformung	
D17 055681	D17 055681	clés plate x2 joint x4	

RMB 03

For VW Group 054257

MADE IN FRANCE

A1 055698	S3 057043	B1 055711	S7 057074	S8 057081	
D8 056039	D9 056046	D17 055681	D8 056039	D17 055681	
D2 055988	S1 057036	D1 055971	D3 055995	D4 055742	
S4 057050	E2 055766	D13 055759	S5 057067	clés plate x2 joints x4	
D10 055674	D11 056060	D15 056077	D16 056084	D6 056015	rivets POP
D7 056022	D12 056053	D5 056008	pour bouchonnage		

RMB 04

For Mercedes-Benz 054264

MADE IN FRANCE

T1 057098	T2 057104	T3 055827	T4 055834
E3 057005	E4 057012	E5 057029	for HR3 arm (use with E3, E4, E5) 057135
clés plate x2		F1 055773	F2 055780
		F4 055803	F3 055797
		F5 055810	

RMB PP01

For Mercedes-Benz 058378

NEW 2017

MADE IN FRANCE

T7 058033	ST1 058071	T6 058026	T5 058019
T10 058064	ST2 058088	T9 058057	T8 058040
E9 058606	E10 058613	E11 058620	for HR3 arms (use with E9, E10, E11) 057135
clés plate x2		F1 055773	F2 055780
		F4 055803	F3 055797
		F5 055810	

RMB 05

For Ford 055872

MADE IN FRANCE

B1 055711	G1 057173	G2 057180	G3 057197	G4 057203	G5 057210	G6 057227
E7 057159	E8 057166	clés plate x2		joints x4		

RMB PP02

For Ford 058835

NEW 2017

MADE IN FRANCE

B1 055711	G1 057173	G2 057180	G3 057197	G4 057203	G5 057210	G6 057227
E7 057159	E12 058828	clés plate x2		joints x4		



GYSPRESS COMPLETE PACKS

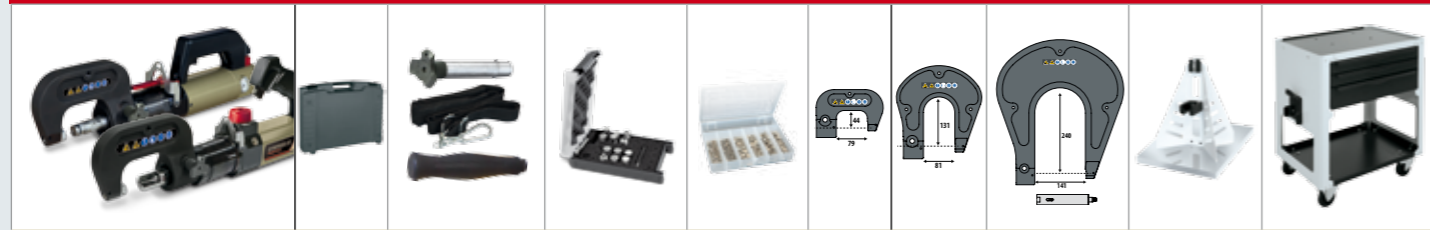

GYSPRESS 8T

pack GYSPRESS 8T
058675

•	HR arm locker + Strap - Sangle - Gurt + Poignée - Handle - Griff	053861	055391
		Standard 8T tool box 053694	Chariot-Trolley 51 x 82 x 74 cm 054233
		6 x 50 rivets - Nieten RAP/SPR Acier/Steel/Stahl 048706	Support - Supportständer 28 x 40 x 21,5 cm 054158
		HR15 054219	HR2 053878
		HR3 053885	

GYSPRESS 8T PUSH PULL

pack GYSPRESS 8T
PUSH PULL
058682

•	HR arm locker + Strap - Sangle - Gurt + Poignée - Handle - Griff	056893	055391
		Standard 8T Push Pull tool box 058361	Chariot-Trolley 51 x 82 x 74 cm 054233
		6 x 50 rivets - Nieten RAP/SPR Acier/Steel/Stahl 048706	Support - Supportständer 28 x 40 x 21,5 cm 054158
		HR15 054219	HR2 053878
		PP HR3 058903	

BRAS DE RIVETAGE (HR) - Riveting arms (HR) - C-Bügel

Gyspress 8t	HR15 054219	HR2 053878	057111	HR3 053885	for HR3 057128	KIT HR2 + HR3 053892
	Gyspress 8t Push Pull		058644	PP HR3 058903	for PP HR3 058637	KIT PP HR2 + HR3 058910

CHARIOT - Trolley

NEW DESIGN

Support Riveteuse pour changements d'accessoires (bras & matrice)
- Riveting machine support for changing accessories (arms & dies)
- Supportständer
↳ 28 x 40 x 21,5 cm
054158

Chariot-Trolley
↳ 51 x 82 x 74 cm
054233

Chariot+Support
Trolley+Support
↳ 51 x 122 x 74 cm
055391

RIVETS AUTOPERÇANTS (RAP) - Self piercing rivets (SPR) - Stanznieten

Steel - Acier - Stahl

Complete box	048706
Ø 3,3 x 3,5 mm x 200	048232
Ø 3,3 x 4 mm x 200	048249
Ø 5,3 x 4 mm x 100	048256
Ø 5,3 x 5 mm x 100	048263
Ø 5,3 x 6 mm x 100	048270
Ø 5,3 x 8 mm x 100	048225
Ø 5,3 x 7 mm x 100	048638
Ø 5,3 x 9 mm x 100	048645

RIVETEUSE HYDRO-PNEUMATIQUE - Hydropneumatic tool for blind rivets - Hydro-pneum. Blindnietgerät

Rivets POP - POP rivets - Blindniet

HR9
Pour rivets Ø 3,2/4,0/4,8 mm (Acier/Alu - Steel/Alu)
max 9 000 N
057234
Made in Taiwan

HR14
Pour rivets Ø 4,0/4,8/6,4 mm (Acier/Alu - Steel/Alu)
max 14 000 N
057241
Made in Taiwan

RIVETEUSE HYDRO-PNEUMATIQUE - Hydropneumatic tool for blind rivets - Hydro-pneum. Blindnietgerät

HR21 Rivets POP - POP rivets - Blindniet

Pour la pose de rivets de structure
max 21 000 N (6 bar)
livré avec kit pour pose de rivets Ø 4,8 à Ø 7,8 mm
055407

included (x3) 058446

MADE IN ITALY

SERTISSEUSE HYDRO-PNEUMATIQUE RIV 998 - Hydropneumatic tool for rivet nuts - Hydro-pneum. Blindnietmuttergerät

RIV 998 Ecrous à sertir - Sealing nuts - Blindnietmuttern

Pour la pose d'écrous à sertir M4 à M12
max 19 000 N (6 bar)
livré avec accessoires pour écrous à sertir M4 à M12
055414

MADE IN ITALY

MINI RIVETEUSE SANS FIL - Cordless riveter - Akku-Blindnietgerät

057968
Rivets Ø 3,2 & Ø 4,0 mm (Ø 4,8 mm alu)
10.8V - 2 Ah Li-ion battery
1.16 kg
Contrôle variable de la vitesse
Balais remplaçables.
↳ 247 x 52 x 190 mm
↳ 345 x 280 x 90 mm

NEW 2017

Variable speed switch
Replaceable carbon brush

PISTOLET À COLLE SANS FIL - Cordless caulking glue gun - Akku-Kartuschenpresse

057975

Speed : 3 > 10 mm/s
Capacity : 400 ml
14.4V - 2 Ah Li-ion battery
2.75 kg
↳ 465 x 130 x 275 mm
↳ 535 x 305 x 156 mm

NEW 2017

MIG/MAG INVERTER DOUBLE PULSE



400 V - 3 Ø

NEOPULSE 270-T2

15 **270 A**

FV TRI no accessories/no trolley : 021983

NEOPULSE 300

15 **270 A**

FV TRI no accessories/no trolley : 032767

NEOPULSE 300-T2

15 **270 A**

FV TRI no accessories : 032729



MERCEDES APPROVED

TESLA APPROVED

FV TRI FLEXIBLE VOLTAGE

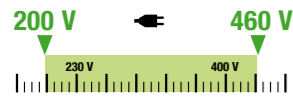

OPTIONS

Potence - Cable support

- for Neopulse 300 032842
- for Neopulse 300-T2 022553

Max 10m² (50L) cooling unit (5L) 033931

INCLUDED Connection 034273

WCT 1.3kW A 400 V, 2~ 1300W, 020344

WCT 1.3kW C 230 V, 2~ 1300W, 032781

CORAGARD CS 330 (10 L) 052246

MADE IN FRANCE EN60974-1	50/60Hz	A	Ø mm	min → max	FV TRI	SPOOLGUN	PUSH/PULL	200	300	Cooling system	ELECTRONIC CONTROL	EN60974-1 (40°C)		cm / kg	Protected & compatible power generator (+/-15%)	
												IA (60%)	X% (I2 max)			
NEOPULSE 270-T2	230V - 3~	20	0.6+1.2	15+220	■	OPTION	OPTION	■	■	Air	4	0.8 / 1.0 mm	190	220 A @ 40%	38x52x64 / 39	10 kVA
	400V - 3~	16		15+270								270 A @ 20%		12.5 kVA		
NEOPULSE 300	230V - 3~	20	0.6+1.2	15+240	■	-	OPTION	■	■	Air	4	0.8 / 1.0 mm	220	240 A @ 60%	38x52x64 / 41	10 kVA
	400V - 3~	16		15+270								240	270 A @ 40%		12.5 kVA	
NEOPULSE 300-T2	230V - 3~	20	0.6+1.2	15+240	■	OPTION	OPTION	■	■	Air	4	0.8 / 1.0 mm	220	240 A @ 60%	84x103x63 / 72	10 kVA
	400V - 3~	16		15+270								240	270 A @ 40%		12.5 kVA	

SIZE N°1 ON MARKET
5" 1/4 ERGONOMIC & EASY

STANDARD MODE EASY & INTUITIVE

PRO MODE 100% PARAMETERS

Stable arc / Constant penetration
Arc stable / pénétration constante

Ideal Alu & CuAl18/CuSi3

SQS SOFT QUICK START®
Vitesse d'accostage contrôlée

Adjustable inductance
Inductance réglable

Soft welding / Hard welding

100% Burnback

Spatter free
- Pas de projection
- Keine Spritzer

Difficult Access
- Accès difficile
- Problempositionen

Gap-Bridging
- Refferment de jour
- Spaltüberbrückung

4 DRIVE ROLLERS
Ø 37 mm, MOTOR 75W
Rollers Type C

ELECTRONIC

DSP FULLY DIGITAL
RJ12 - Software update

SYNERGIES UPDATE
- Mise à jour des synergies

SD CARD 050914

NEOPULSE COMPLETE PACKS

NEOPULSE 300	TYPE C	cooling unit (5L) liquid not included	Fe/CrNi	Alu	Push-Pull Alu			
pack NEOPULSE 300 A1 032682	Ø 0.8/1 (x2) (Original Equipment)	4 m, 35 mm ² 043817	845 x 982 x 605 mm 033931	Cable support 032842	250 A, 3 m, air 040700			
pack NEOPULSE 300 A2 032705	Ø 0.8/1 (x2) (Original Equipment)	Alu, Ø 1/1.2 (x2) 042162	4 m, 35 mm ² 043817	845 x 982 x 605 mm 033931	Cable support 032842	250 A, 3 m, air 040724		
pack NEOPULSE 300 A3 022744	Ø 0.8/1 (x2) (Original Equipment)	Alu, Ø 1/1.2 (x2) 042162	4 m, 50 mm ² 047853	845 x 982 x 605 mm 033931	Cable support 032842	220 A, 4 m 046283		
pack NEOPULSE 300 A4 022843	Ø 0.8/1 (x2) (Original Equipment)	Alu, Ø 1/1.2 (x2) 042162	4 m, 50 mm ² 047853	845 x 982 x 605 mm 033931	Cable support 032842	250 A, 3 m, air 040724		
pack NEOPULSE 300 A PUSH PULL 022706	Ø 0.8/1 (x2) (Original Equipment)	Alu, Ø 1/1.2 (x2) 042162	4 m, 35 mm ² 043817	845 x 982 x 605 mm 033931	Cable support 032842	220 A, 4 m 046283		
pack NEOPULSE 300 W1 032699	(Original Equipment)	4 m, 35 mm ² 043817	845 x 982 x 605 mm 033931	WCT 1.3kW A 020344	Cable support 032842	300 A, 3 m, liquid 040694		
pack NEOPULSE 300 W2 032712	Ø 0.8/1 (x2) (Original Equipment)	Alu, Ø 1/1.2 (x2) 042162	4 m, 35 mm ² 043817	845 x 982 x 605 mm 033931	WCT 1.3kW A 020344	Cable support 032842		
pack NEOPULSE 300-T2 022607	Ø 0.8/1 (x2) (Original Equipment)	Alu, Ø 1/1.2 (x2) 042162	4 m, 35 mm ² 043817	845 x 982 x 605 mm 033931	Cable support 022553	250 A, 3 m, air 040700		
						220 A, 4 m 046283	Ø 0.8 Alu 041059	Ø 1 Alu 041066

PUSH PULL TORCH - 24 V

OPTION NEOPULSE 270-T2, 300, 300-T2

Light weight

Welding Parameters access:

- Speed
- Arc length
- Select
- Adjust +/-

Ideal Alu MB15
Ø 0,8
160 A (40%)
Original equipment : Ø 0,6/0,8-1,0
2,9 kg
4m 044111

Ideal Alu MB25
Ø 1,2
220 A (20%)
Original equipment : Ø 0,8-1,0/1,2
4m 046283
6m 048713
option Ø 0,6/0,8-1,0
046290

SPOOLGUN

OPTION M1/T1/M3/T3 GYS AUTO, NEOPULSE 270-T2, 300-T2

Torche motorisée Spool Gun - Spool Gun Torch
- Spool Gun Brenner
041486

Ideal Alu
Ø 0,8
& Acier/Steel/Stahl
& Inox/Stainless steel

4m

BOBINES DE FIL
- Welding wire reels - Drahtrollen - Rollos de hilo - Draadbobijn
- Bobines de filo

	kg	Ø	EXCELLIUM				NORMES - Norms - Normen - Norma		
			Ø 0.6 mm	Ø 0.8 mm	Ø 1.0 mm	Ø 1.2 mm	AWS	EN	DIN
Acier - Steel - Stahl - Acero - Staal - Aço (SG2)	0.9	100 mm	086593	086609					
	5	200 mm	086111	086128	086135				
	15	300 mm	086166	086227	086234	086241			
	15	300 mm		086258					
Acier - Steel - Stahl - Acero - Staal - Aço (UHSS)	5	200 mm		086203					
Galva (G2Ti)	5	200 mm	086760	086777					
Alu (AlMg3)	2	200 mm						086517	
	7	300 mm						086500	
Alu (AlMg5)	0.5	100 mm		086548					
	2	200 mm		086555	086562				
	7	300 mm			086524	086531			
Alu (AlSi5)	0.5	100 mm		086685					
	2	200 mm			086142	086159			
Alu (AlSi12)	0.5	100 mm		086678					
	2	200 mm			086067	086074			
Inox - Stainless - Edelstahl (308LSi)	1	100 mm		086616					
	5	200 mm		086579	086340				
Inox - Stainless - Edelstahl (316LSi)	15	300 mm			086357				
	5	200 mm		086326	086364				
Cusi3 HLE - UHTS (Boron Steel)	15	300 mm			086371				
	1	100 mm		086692					
CuAl8 HLE - UHTS (Boron Steel)	5	200 mm		086647	086654			086210	
	15	300 mm		086661	086197			086180	

ADAPTATEURS BOBINES - Adaptors for wire reels
- Korbspulenadapter

ALIGNER 200
Ø 200
042889

After sales

Professional Ø 200 & 300 71608

Industrial Ø 200 & 300 71613

Press & Lock

PINCE SPÉCIALE MIG/MAG - ORIGINAL FIX - Special MIG/MAG plier - Spezial MIG/MAG Zange - Pinza especial MIG/MAG

PRO (x1)
041332

1) Clean 2) Cut 3&4) Prepare (contact tube & nozzle)

SUPPORT TORCHE MAGNÉTIQUE
- MIG torch stand with magnetic base

041653

GALETS - Rollers - Vorschubrollen - Rollen - Rodillos - Wielen - Roletes

	TYPE A	TYPE B	TYPE C
Acier - Steel - Stahl - Acero - Staal - Aço - Stainless	Ø 0.6 / 0.8 (x1) Ø 0.8 / 1.0 (x1) Ø 1.0 / 1.2 (x1) Ø 1.2 / 1.4 (x2)	Ø 0.6 / 0.8 (x1) Ø 0.8 / 1.0 (x1) Ø 1.0 / 1.2 (x1) Ø 1.2 / 1.4 (x2)	Ø 0.6 / 0.8 (x1) Ø 0.8 / 1.0 (x1) Ø 1.0 / 1.2 (x1) Ø 1.2 / 1.4 (x2)
Alu	Ø 0.8 / 1.0 (x1) Ø 1.0 / 1.2 (x1) Ø 1.2 / 1.6 (x2)	Ø 0.8 / 1.0 (x1) Ø 1.0 / 1.2 (x1) Ø 1.2 / 1.6 (x2)	Ø 0.8 / 1.0 (x1) Ø 1.0 / 1.2 (x1) Ø 1.2 / 1.6 (x2)

COFFRETS - Boxes - Kästen - Cajas - Kistjes - Estojes

MB 15 (150 A)
041226

MB 25 (250 A)
041233

MB 36 (350 A)
041417

TORCHES COMPLÈTES - Complete Torches - Brenner - Antorcha - Lastoorl - Tocha

BINZEL

360° GRIP CONFORT
ERGONOMIC CONCEPT

Torches aspirantes
- Fume Extraction Torches
- Rauchgas-Absaugbrenner
- Antorcha con aspiración de humos

Ref.	ACIER / INOX - Steel/Stainless steel - Stahl/Edelstahl						ALU - Aluminium - Aluminio						
	AIR			LIQUID			AIR			LIQUID			
	150 A	250 A	300 A	150 A	250 A	300 A	150 A	250 A	300 A	150 A	250 A	300 A	
	041424	043268	043251	040700	040922	040540	040694	043275	041462	040724	040939	040748	043282
GRIP	3m	3m	3m	3m	4m	3m	3m	4m	3m	3m	4m	3m	4m
X% 40°C-ArCo ₂	150A - 60%	150A - 60%	150A - 60%	200A - 60%	200A - 60%	200A - 60%	270A - 100%	270A - 100%	150A - 60%	200A - 60%	200A - 60%	270A - 100%	270A - 100%
original equipment	A	A	A	B	B	B	C	C	A	B	B	C	C
original equipment	M6	M6	M6	M6	M6	M6	M6	M6	M6	M6	M6	M6	M6
	Ø0.8	Ø0.8	Ø0.8	Ø1.0	Ø1.0	Ø1.0	Ø1.2	Ø1.2	Ø0.8	Ø1.0	Ø1.0	Ø1.2	Ø1.2

CONSOMMABLES - Consumables

1 2 3 4

A1 A2 B1 B2 C1 C2 D1 D2 E1 E2 F

A B C D E F

1	ACIER / INOX - Steel/Stainless steel - Stahl/Edelstahl						ALU - Aluminium - Aluminio					
	AIR			LIQUID			AIR			LIQUID		
	150 A	250 A	300 A	150 A	250 A	300 A	150 A	250 A	300 A	150 A	250 A	300 A

1 SUPPORTS TUBE CONTACT & DIFFUSEURS - Tip adaptors & diffusers

	150 A	250 A	300 A	150 A	250 A	300 A
A1 (x5)	042902	042995	043589	042902	042995	043589
A2 (x10)	042988	042919	043541	042988	042919	043541

2 TUBES CONTACTS - Contact tips - Kontaktrohre - Tubo de contacto - Contactbuis - Pontas de contacto (x10)

	150 A	250 A	300 A	150 A	250 A	300 A
Ø 0.6	041905	041905	041905			
Ø 0.8	041912	041950	041950	041059	041059	041059
Ø 1.0	041929	041967	041967	041066	041066	041066
Ø 1.2	040144	041974	041974	041073	041073	041073

3 BUSES - Gas nozzles - Düsen - Tubo - Nippel - Bicos

	150 A Ø12	250 A Ø15	300 A Ø17	150 A	250 A Ø15	300 A
Conique - Conical nozzle - Konische Düse	A (x3) 041875 E (x1) 043084	A (x3) 041882 E (x1) 040571	A (x3) 043534	Ø12 A (x3) 041875	A (x3) 041882	Ø12 A (x3) 043534
Pointage - Spot welding - Punktöse	B (x1) 041851			B (x1) Ø12 041851		Ø17 F (x3) 046221
Soude dou - Nail welding - Nagelschweißöse	C (x1) 041523			F (x3) Ø16 046214		

4 GAINES - Torch liners - Mantel - Funda - Drahtseelen - Folha

	Acier - Steel - Stahl - Acero - Staal - Aço						Teflon	
	3 m	4 m	3 m	4 m	3 m	4 m	3 m	4 m
Ø 0.6/0.8	041592	041837	041592	041837	041578	044050	041578	044050
Ø 1.0/1.2	041608	041844	041608	041844	041585	044067	041585	044067
					Carbon			
Ø 0.6/0.8					039834			

HELMETS

TEINTE
SHADE **9/13**

EN 175-EN 379



LCD TECHNO 9/13
042544

MASTER IRON 9/13 G
038325
MASTER BONES 9/13 G
038318
MASTER LCD 9/13 G
040861



LCD PROMAX 9/13 G GOLD
045767
LCD PROMAX 9/13 G SILVER
045774

LCD EXPERT 9/13 G CARBON
040878

LCD EXPERT 9/13 G BLUE
042216

ERGOTECH 5-9/9-13 SILVER
044173
ERGOTECH 5-9/9-13 BLACK
045477



LCD HERMÈS SILVER
040908
LCD HERMÈS RED
040885
LCD HERMÈS GOLD
040892

LCD ZEUS INDIAN 5-9/9-13 G
038332
LCD ZEUS FIRE 5-9/9-13 G
044098
LCD ZEUS COSMIC 5-9/9-13 G
044104



GYSMATIC 9/13 G
043909

GYSMATIC 5/13 XXL
046818

LCD SPACEVIEW 5-9/9-13
040717

LCD AUTOMATIC TECHNOLOGY	BASIC		PRO			PRO+		EXPERT		EXPERT+	
MODEL	TECHNO	MASTER	PROMAX	EXPERT	HERMES	ZEUS	ERGOTECH	GYSMATIC	SPACEVIEW	GYSMATIC AIR	NAVITEK
REF	042544	(iron) 038825 (bones) 038318 (lcd) 040861	(gold) 045767 (silver) 045774	(carbon) 040878 (blue) 042216	(silver) 040908 (red) 040885 (gold) 040892	(indian) 038332 (fire) 044098 (cosmic) 044104	(silver) 044173 (black) 045477	043909 046818	040717	047846	045842
	0.30 ms	0.30 ms	0.25 ms	0.30 ms	0.30 ms	0.20 ms	0.20 ms	0.08 ms	0.10 ms	0.10 ms	0.10 ms
	4 - 9>13	4 - 9>13	4 - 9>13	4 - 9>13	4 - 9>13	5>9 9>13	5>9 9>13	4 - 9>13	4 - 5>13	5>9>13	4 - 5>13
	1/2/1/1	1/2/1/2	1/1/1/2	1/1/1/2	1/1/1/3	1/1/1/2	1/1/1/2	1/1/1/2	1/2/1/1	1/1/1/2	1/1/1/2
MEMORY & REGULATIONS								ELECTRONIC		ELECTRONIC	ELECTRONIC
	92x42 mm	92x42 mm	100x49 mm	98x43 mm	98x43 mm	XL : 100x67 mm	XL : 100x67 mm	100x60 mm	XXL : 100x83 mm	XXL : 100x83 mm	100 x 50 mm
	2	2	2	2	2	4	4 HIGH SENSITIVITY	4 HIGH SENSITIVITY	4 HIGH SENSITIVITY	4 HIGH SENSITIVITY	4 HIGH SENSITIVITY
		✓	✓	✓	✓	✓	✓	✓	✓	✓	nc
						✓	✓	✓	✓	✓	✓
	☀	☀	☀	☀ + 2 (CR 2032)	☀ + 2 (CR 2032)	☀ + 2 (CR 2450)	☀ + 2 (CR 2450)	☀ + 2 (CR 2450)	☀ + 1 (CR 2450)	☀ + 1 (CR 2450)	☀ + 2 (CR 2330)
	Simple	Simple	Simple	Simple	Simple	Multi	Multi	Simple	Multi	Simple	Simple
	440 g	450 g	385 g	510 g	510 g	515 g	560 g	450 g	460 g	530 g	2.4 kg
BRAND MASK	Toolit	Top Arc	Toolit	Toolit	Toolit	Toolit	Top Arc	Gys	Toolit	Gys	Gys



VERRES - Linse - Schutzgläser

110 x 90	x5	040816	116 x 89,5	x5	040779	226 x 106	x5	045781	111.2x91	x5	040793	111.2x91	x5	040793	114 x 133	x10	043893	114 x 133	x10	043893	114 x 133	x10	043893	114 x 133	x10	043893	114 x 133	x10	043893	110 x 97	x10	045798			
95.5 x 50.5	x5	040854	103.5 x 53	x5	040786	104 x 55	x5	040847	103.6 x 54	x5	040809	103.6 x 54	x5	040809	103.7 x 69.5	x5	043695	103.7 x 69.5	x5	043695	G:106 x 66	x10	043886	XXL:106x89,5	x10	046825	104 x 96	x5	043596	106 x 89,5	x10	046825	98 x 47	x10	045811

INDUCTION HEATING

1 ⌀

HAND-DUCTION HEATING SYSTEM



NEW 2017

1 000 W

with accessories • EUR • 230 V : 056923

UK : 057371 (230V)
US : 057395 (110V)
AU : 057388 (230V)

L : 37cm • Ø : 8.2 cm • 2.54kg • 5A
40-80 KHz



INCLUDED

Spirale - Coil - Spiralförmiger draht	Fil tressé enroulable - Flexible wrappable wire - Flexibel geflochtener draht	Fil droit rigide - Straight rigid wire - Steif gerade draht
Ø 22mm (7/8 in.)	1 m (41 in.)	584 mm (23 in.)

MADE IN HIGH QUALITY USA

Ergonomique et léger
- Lightweight and ergonomic design
- Leicht und einfach zu Bedienen

Refroidi air
- Air cooled - Luftgekühlt

Verrouillage facile des inducteurs
- Coil Twist Lock
- Einfaches Verriegeln der Induktoren

Éclairage LED
- Light LED
- LED zum Erhitzen des Blechs



GYSDUCTION AUTO

2 400 W

PFC



PFC POWER FACTOR CORRECTION

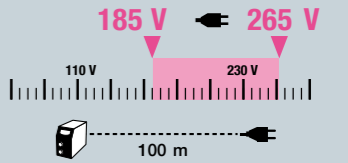

COMPLETE

	Décapage - Glass - Entfernen 053373
	Démontage - Decal - Entkleben 053359
	Dégrippage - Bolt heating - Lösen 053366



Protection (x5)
+ Colle - Stick
053854



Protection (x10)
+ Colle - Stick
053847

OPTION

Spray refroidisseur
- Freezer spray

-50 °C
400 ml

(x 12)
048898



Adhesive for logo
(x10)
051492

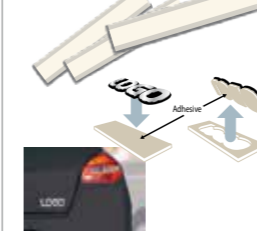

Débosselage rapide et sans peinture
- Fast and paintless dent pulling
- Lackschadenfreies Ausbeulen
054776
Licensed by BETAG innovation



3 m

1.2 kW



3 m

Spirale - Coil - Spiralförmiger draht

	Ø 18 mm 054806
	Ø 24 mm 054790
	Ø 30 mm 055469
Fil tressé enroulable - Flexible wrappable wire - Flexibel geflochtener draht	
	800 mm 054813
Fil droit rigide - Straight rigid wire - Steif gerade draht	
	800 mm 054868

PACKS GYSDUCTION AUTO

1 box

GYSDUCTION AUTO

	GYSDUCTION AUTO	Plastic wedges 051294	Burn off Inductor Décapage - Burn off - Entfernen 053373	Body Inductor Démontage - Removal - Abkleben 053359	Bolt Inductor Dégrippage - Heating - Lösen 053366	Remote control Télécommande - Fußschalter 055490	Trolley SPOT 800 051331	Cable support 052284	Dent pulling Inductor Débosselage - Dent pulling - Ausbeulinduktor 054776	Spiral inductor - Inducteur spirale - Spiralinduktor 054783
PROLINER AUTO 048775	<input checked="" type="checkbox"/>	<input checked="" type="checkbox"/>	<input checked="" type="checkbox"/>	<input checked="" type="checkbox"/>	<input checked="" type="checkbox"/>	<input checked="" type="checkbox"/>	<input checked="" type="checkbox"/>	<input checked="" type="checkbox"/>	<input checked="" type="checkbox"/>	<input checked="" type="checkbox"/>
COMPLETE AUTO 053380	<input checked="" type="checkbox"/>	<input checked="" type="checkbox"/>	<input checked="" type="checkbox"/>	<input checked="" type="checkbox"/>	<input checked="" type="checkbox"/>	<input checked="" type="checkbox"/>	<input checked="" type="checkbox"/>	<input checked="" type="checkbox"/>	<input checked="" type="checkbox"/>	<input checked="" type="checkbox"/>
COMPLETE AUTO + 056978	<input checked="" type="checkbox"/>	<input checked="" type="checkbox"/>	<input checked="" type="checkbox"/>	<input checked="" type="checkbox"/>	<input checked="" type="checkbox"/>	<input checked="" type="checkbox"/>	<input checked="" type="checkbox"/>	<input checked="" type="checkbox"/>	<input checked="" type="checkbox"/>	<input checked="" type="checkbox"/>
MECA AUTO 048812	<input checked="" type="checkbox"/>	<input checked="" type="checkbox"/>	<input checked="" type="checkbox"/>	<input checked="" type="checkbox"/>	<input checked="" type="checkbox"/>	<input checked="" type="checkbox"/>	<input checked="" type="checkbox"/>	<input checked="" type="checkbox"/>	<input checked="" type="checkbox"/>	<input checked="" type="checkbox"/>
MECA AUTO + 056961	<input checked="" type="checkbox"/>	<input checked="" type="checkbox"/>	<input checked="" type="checkbox"/>	<input checked="" type="checkbox"/>	<input checked="" type="checkbox"/>	<input checked="" type="checkbox"/>	<input checked="" type="checkbox"/>	<input checked="" type="checkbox"/>	<input checked="" type="checkbox"/>	<input checked="" type="checkbox"/>
BODY SHOP AUTO 048799	<input checked="" type="checkbox"/>	<input checked="" type="checkbox"/>	<input checked="" type="checkbox"/>	<input checked="" type="checkbox"/>	<input checked="" type="checkbox"/>	<input checked="" type="checkbox"/>	<input checked="" type="checkbox"/>	<input checked="" type="checkbox"/>	<input checked="" type="checkbox"/>	<input checked="" type="checkbox"/>
GLASS AUTO 048805	<input checked="" type="checkbox"/>	<input checked="" type="checkbox"/>	<input checked="" type="checkbox"/>	<input checked="" type="checkbox"/>	<input checked="" type="checkbox"/>	<input checked="" type="checkbox"/>	<input checked="" type="checkbox"/>	<input checked="" type="checkbox"/>	<input checked="" type="checkbox"/>	<input checked="" type="checkbox"/>
DENT REPAIR AUTO 054981	<input checked="" type="checkbox"/>	<input checked="" type="checkbox"/>	<input checked="" type="checkbox"/>	<input checked="" type="checkbox"/>	<input checked="" type="checkbox"/>	<input checked="" type="checkbox"/>	<input checked="" type="checkbox"/>	<input checked="" type="checkbox"/>	<input checked="" type="checkbox"/>	<input checked="" type="checkbox"/>

EN-60 335/1	MADE IN FRANCE	50/60 Hz	A	W	kHz	Freq.	INTEGRATED TECHNOLOGY	PFC	FV	Liquid Cooling	Cable L (m)	Inductor	cm	kg
GYSDUCTION AUTO		230V, 1~	16	2400	35+120						2	2.5	22 x 36 x 27	7.2

INDUCTION HEATING SYSTEM



POWERDUCTION 37LG
3 700 W



no accessories:
056992

OPTIONS



NEW
11/2017

2 m

POWERDUCTION 39LG
3 700 W



no accessories:
058583

PFC POWER FACTOR CORRECTION

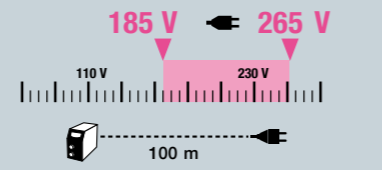

NEW
10/2017

3 m

POWERDUCTION 50LG
5 200 W



no accessories:
055599

PFC POWER FACTOR CORRECTION

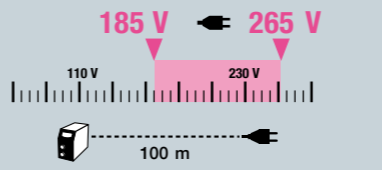

3 m



POWERDUCTION 160LG
16 000 W



no accessories:
057814

NEW
12/2017



6 m

OPTIONS

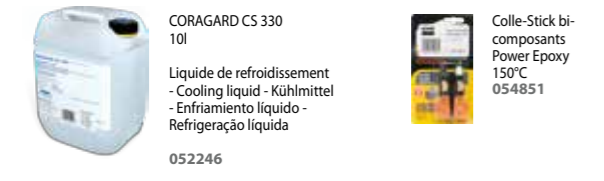

37LG



39LG & 50 LG

056862	20°	053823	056909
056879	90°	053823	056909
056886		053458	056916

 60974/1	 MADE IN FRANCE	⚡	⚡	⚡	Freq.	INTEGRATED TECHNOLOGY	❄️	Cable L (m)		 400V Tested in Production	 cm	 kg
		Hz	A	W	kHz	PFC	Liquid Cooling	Inductor				
POWERDUCTION 37LG		230 V, 1~, 50/60 Hz	16 mini	3 700	15+30	—	▪	2	2	—	45 x 28.5 x 25	15
POWERDUCTION 39LG		230 V, 1~, 50/60 Hz	16 mini	3 700	30+50	▪	▪	2	3	▪	53 x 70 x 37	50
POWERDUCTION 50LG		230 V, 1~, 50/60 Hz	25 mini	5 200	30+50	▪	▪	8	3	▪	88 x 59 x 59	70
POWERDUCTION 160LG		400 V, 3~, 50/60 Hz	32 mini	16 000	25+40	—	▪	5	6	—	70 x 1015 x 60	150

PLASMA CUTTER

1 Ø



EASYCUT 40

40 A

ALU xx mm
INOX/STEEL xx mm

with accessories:
029743



NEW 2017

INCLUDED:
8 mm
10 mm



PFC POWER FACTOR CORRECTION

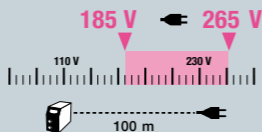

AD ANTI-DUST VENTILATION CORRIDOR



FV FLEXIBLE VOLTAGE

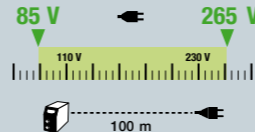

Kompressor INSIDE

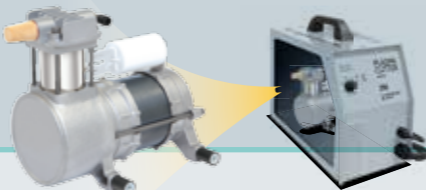

CUTTER 25 K

25 A

ALU 4 mm
INOX/STEEL 6 mm

20 A on 13 A fuse

with accessories:
030947



ERGOCUT S25K



CUTTER 35 KF

35 A

ALU 8 mm
INOX/STEEL 12 mm

30 A on 13 A fuse

with accessories:
031036



ERGOCUT S35K



AIR FILTER



CUTTER 31 FV

30 A

ALU 8 mm
INOX/STEEL 10 mm

30 A on 13 A fuse

with accessories:
030985



ERGOCUT S45



RENAULT

www.renault-equipment.com



CUTTER 40 FV

40 A

ALU 10 mm
INOX/STEEL 15 mm

30 A on 13 A fuse

with accessories:
031043

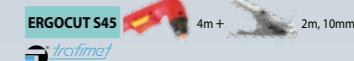

ERGOCUT S45



INCLUDED:
8 mm
10 mm

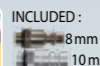

ACCESSOIRES / ACCESSORIES



x1 040199

only for ERGO CUT

040205

R max = 670 mm

CONSOUMMABLES / CONSUMABLES

ERGO CUT	S 25K	S 35K	S 45
	x4 040182	x4 040229	x4 040236
	x10 040151	x10 040212	x10 040212
	x2 040175	x2 040175	x2 040175
	x10 040168	x10 040168	x10 040168
Coffret - Box	039971	039964	039957

Chariot/Trolley/Fahrgewagen



PLASMA 600 040298

SPOT 800 051331

Jobsite XL 039568

Filtre déshumidificateur spécial Plasma - Compressed air cleaning filter for Plasma Cutter 31/40 039728



Cartouche pour filtre - Filter cartridge 039735

MADE IN GYS CHINA	50/60 Hz	I ₂	mm				INTEGRATED TECHNOLOGY				AIR SYSTEM			EN 60974-1 (40°C)		cm	kg	Protected & compatible power generator (+/-15%)			
			Max Cut	Clean Cut	PFC	FV	AD	KOMPRESSOR INSIDE	mini	ideal	maxi	IA 60%	X% I2 max								
MADE IN FRANCE	EASYCUT 40	230V 1~	16	20+40	15	10	10	8	—	—	—	—	2.5 bar	4.5 bar 115l/m	6.5 bar	20 (50%)	20	15 x 42 x 30	8	8 kW	11 kVA
	CUTTER 25K	230V 1~	16	5+25	6	4	4	3	—	—	—	—	included	—	—	12	26	22 x 45 x 31	17.2	4.1 kW	5.9 kVA
	CUTTER 35KF	230V 1~	16	10+35	12	8	8	6	—	—	—	—	included	—	—	28	30	28 x 52 x 46	30	8 kW	10 kVA
	CUTTER 31FV	230V 1~	16	5+30	10	8	7	5	—	—	—	—	2.5 bar	4.5 bar 115l/m	9 bar	22	32	19 x 44 x 28	12	6 kW	7.5 kVA
CUTTER 40FV	110V 1~	32	5+30	—	—	—	—	—	—	—	—	—	—	—	—	19	25	—	—	—	—
	230V 1~	16	10+40	15	10	10	8	—	—	—	—	—	2.5 bar	4.5 bar 115l/m	9 bar	32	40	21 x 51 x 37	20	8 kW	10 kVA
CUTTER 40FV	110V 1~	32	10+30	—	—	—	—	—	—	—	—	—	—	—	—	25	40	—	—	—	—

COFFRET DE DÉCOUPE PARE-BRISE
- Professional Box Set for Windscreen Removal - Frontscheiben-Trennsystem für Akkuschrauberbetrieb

057654

NEW 2017

MADE IN HIGH QUALITY GERMANY



included
65 m
058125



COUPEAU PNEUMATIQUE DE DÉCOUPE PARE-BRISE
- Oscillating Pneumatic Saw for Windscreen Removal - Druckluft-Trennmesser für Windschutzscheiben

057623

NEW 2017



90 mm 057852 57 mm 057845

8 mm 057876 35 mm 057838

U 36 mm 057869

COFFRET PRO DE RÉPARATION PARE-BRISE - Professional Boxset for Windscreen Repair - Frontscheiben-Reparatursystem

057661

NEW 2017

MADE IN HIGH QUALITY DENMARK

HBC system

- films UV - UV films - UV-Film (x10) 058163
- lames de rasoir - Razor blades - Ersatzklinge (x10) 058156
- seringues 1 ml + aiguilles - 1ml syringes and needles - Spritze 1ml und Kanüle (x3) 058170
- frises bleues - Blue drill - Glasbohrer blau (x2) 058132
- frises jaunes - Yellow drill - Glasbohrer gelb (x2) 058149
- polish de finition - Finishing polish - Finishingpolitur (15 ml) 058200
- résine injection - Injection resin - Injektionsharz (5 ml) 058187
- résine de finition - Finishing resin - Finishingharz (5 ml) 058194



SYSTÈME DE DÉCOUPE PARE-BRISE A CLIQUET
- Windshield Cutting kit - Kit zum Lösen von Windschutzscheiben

054738



Diagrams showing the cutting process on a windshield.

PROTECTIONS TABLEAU DE BORD
- Dashboard Protector - Armaturenbrett Schutz

053120



EXTRACTEUR D'ESSUIE-GLACE - Removal tool for windscreen wiper arms - Wischerarm-Abzieher

UNIVERSEL 057630

NEW 2017

30 mm max

EXPERT 057647

Accès difficile - Difficult access

NEW 2017

40 mm max



VENTOUSES - Suction Lifting Pads - Saugnapfwerkzeug für Spiegelgläser

056695

Ø 70 mm

051966 x2

x6 057609

NEW 2017

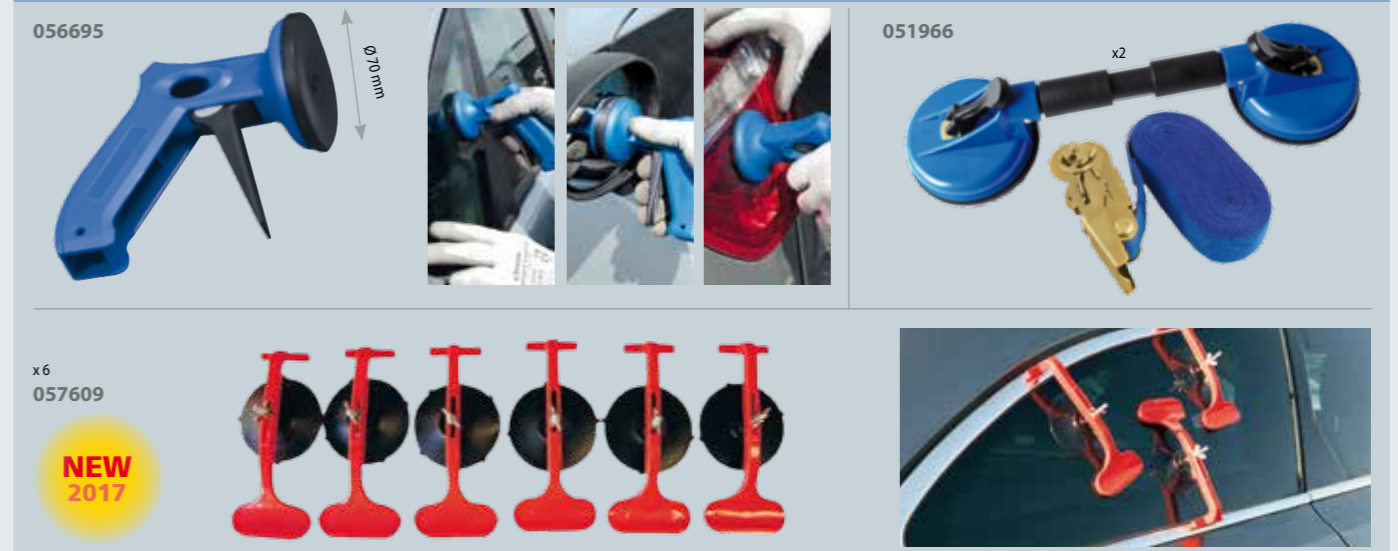

OUTIL DÉCOUPE PARE-BRISE
- Windshield Cutting Tool - Windschutzscheiben-Ausglas-Set

051935



KIT DÉCOUPE JOINT DE PARE-BRISE - Windscreen Joint-cutting Kit - Scheibentrenn-Werkzeug-Set

051898

051911

051881

Corde à piano torsadé (22 m) - Windscreen seal cutting wire (twisted) - Piano-Schneiddraht, gedreht, 22 m Rolle

Corde à piano carré (50m) - Windscreen seal cutting wire (square) - Vierkant-Draht, 50 m Rolle



RENOV'POLYCARBONATE - Compressed air polisher - Druckluftpolierer

052086

2 SPEED

sander Ø75 057494

052055

052062

052079

Ø 76

P 500 (x 10)

P 800 (x 10)

P 1500 (x 10)

P 3000 (x 10)

polisher Ø75 058224

Complete pack

1 ponceuse orbitale + 1 lustreuse + 1 orbital sander + 1 polisher



AGRAFEUSE POUR RÉPARATION PARE-CHOCS - Hot stapler for bumper repair - Stoßstangen Reparatur Kit

052925
US : 056947 (110V)



INCLUDED :
x20 x20 x20 x20 x20

MADE IN TAIWAN

PORTABLE
Sur batterie - Battery operated
058118

included
Li-ion battery 3.7V
048669
included adapters :
EUR, UK, USA & AUS

INCLUDED :
Ø 0.6, x100 Ø 0.8, x100 Ø 0.6, x100

MADE IN TAIWAN



NEW 2017

Agrafes - staples	V Angle interne étroit - Inside corner Ø 0.7 mm	U Alignement de fissure - Crack alignment Ø 0.7 mm	N Fissure importante - Large crack Ø 0.7 mm	W Angle interne - Internal angle Ø 0.7 mm	M Angle externe - External angle Ø 0.7 mm
x 100 047990	x 100 047983	x 100 047976	x 100 047969	x 100 047952	
052413					
x 50	+	x 50	+	x 50	+
					x 50



KIT DE SOUDAGE DES PLASTIQUES - Welding Kit for Plastics - Kunststoff-Schweißset

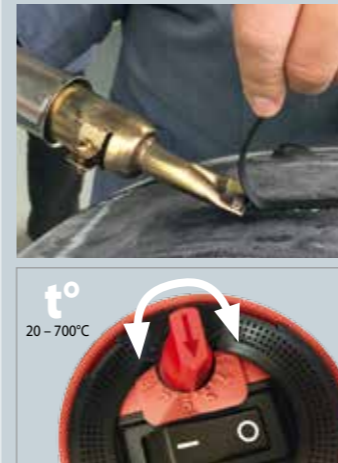

057678 =

1 600 W - 230V - 50/60 Hz
max. 230 l/mn
▲ 1.3 kg / -L Ø100 x 300mm,
poignée Ø 56mm.

20mm

NEW 2017



ADHÉSIF BICOMPONENTS POUR RÉPARATION PARE-CHOCS - Dual Component Bonding Gun for Plastic Repairs - 2-Komponenten-Klebekit für Stoßfänger

057685 =

120 s / 50 ml
included x2
30 s / 50 ml
Séchage rapide
- Fast dry
- Schnelltrockner
included x1



NEW 2017

120 s / 50 ml
057722
x6 x10
30 s / 50 ml
Séchage rapide
- Quick dry
057715
x6 x10
x10
057708

COFFRET DE RÉPARATION DES PLASTIQUES AUTOMOBILES - Brazing automotive plastics repair kit - Kunststoff Reparatur Kit



052932 =

MADE IN BELGIUM



Spray refroidisseur
- Freezer spray
-50 °C
400 ml
(x 12)
048898

COFFRET DE PERÇAGE PARE-CHOCS POUR DÉTECTEURS - Piercing Kit for Bumper Sensors - Lochwerkzeug für Stoßfänger



NEW 2017

BASIC
057739



NEW 2017

PRO
057746



MADE IN
HIGH
QUALITY
GERMANY

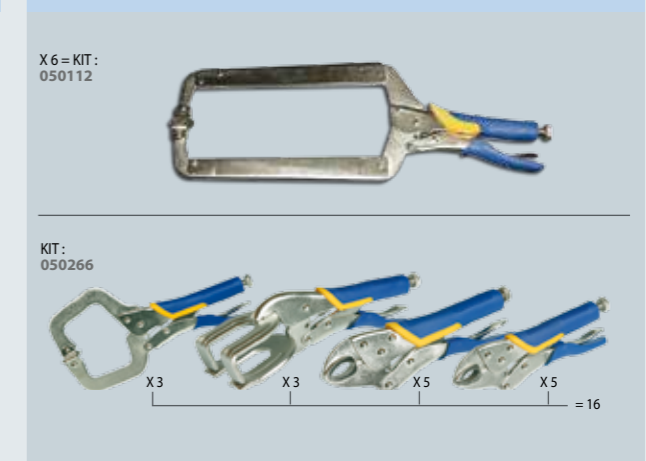
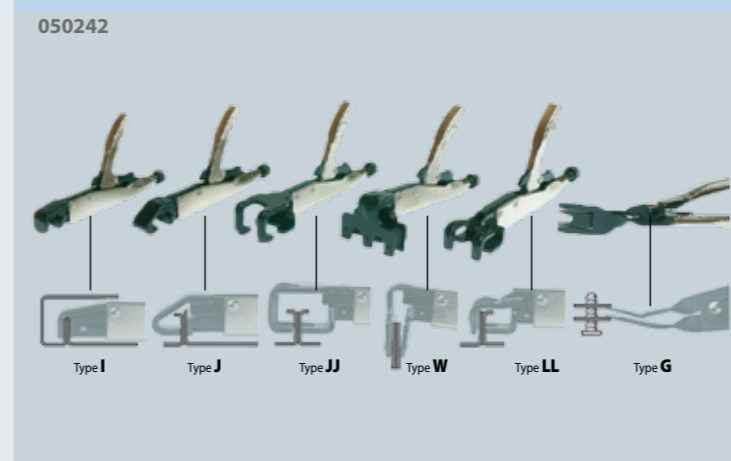
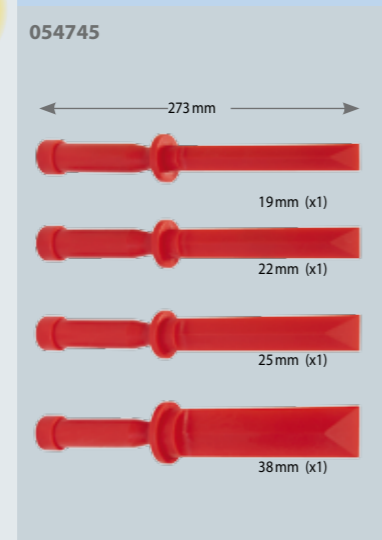
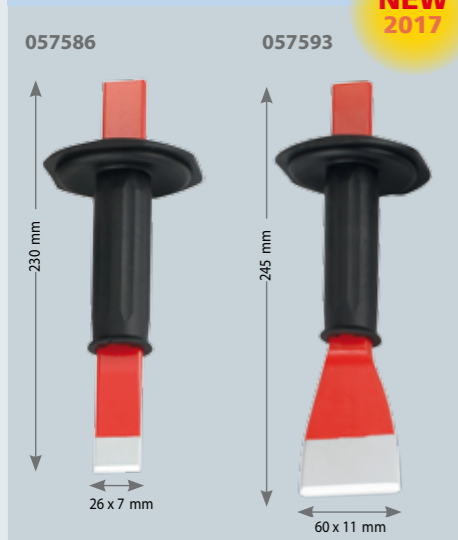
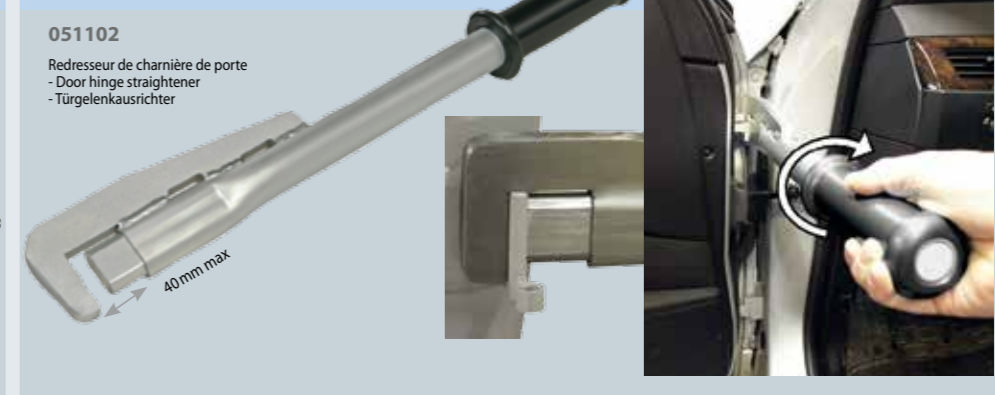
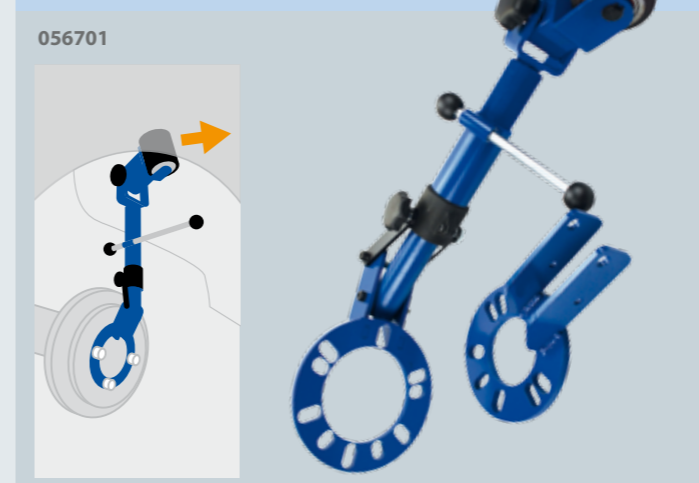
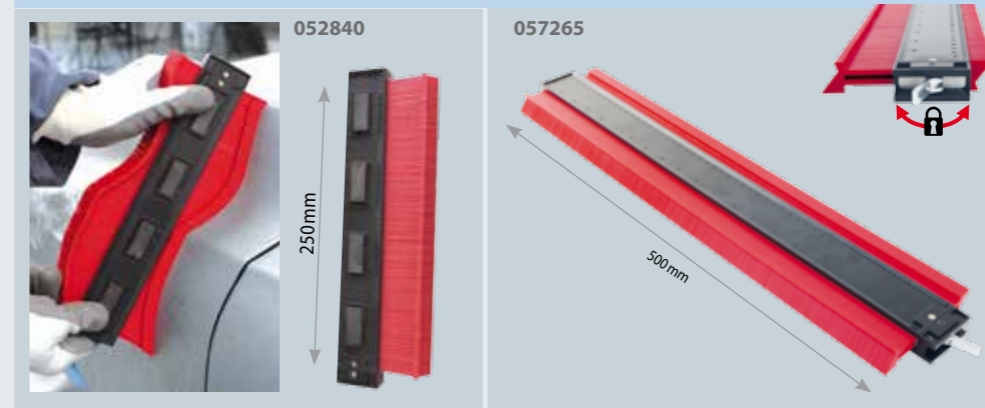
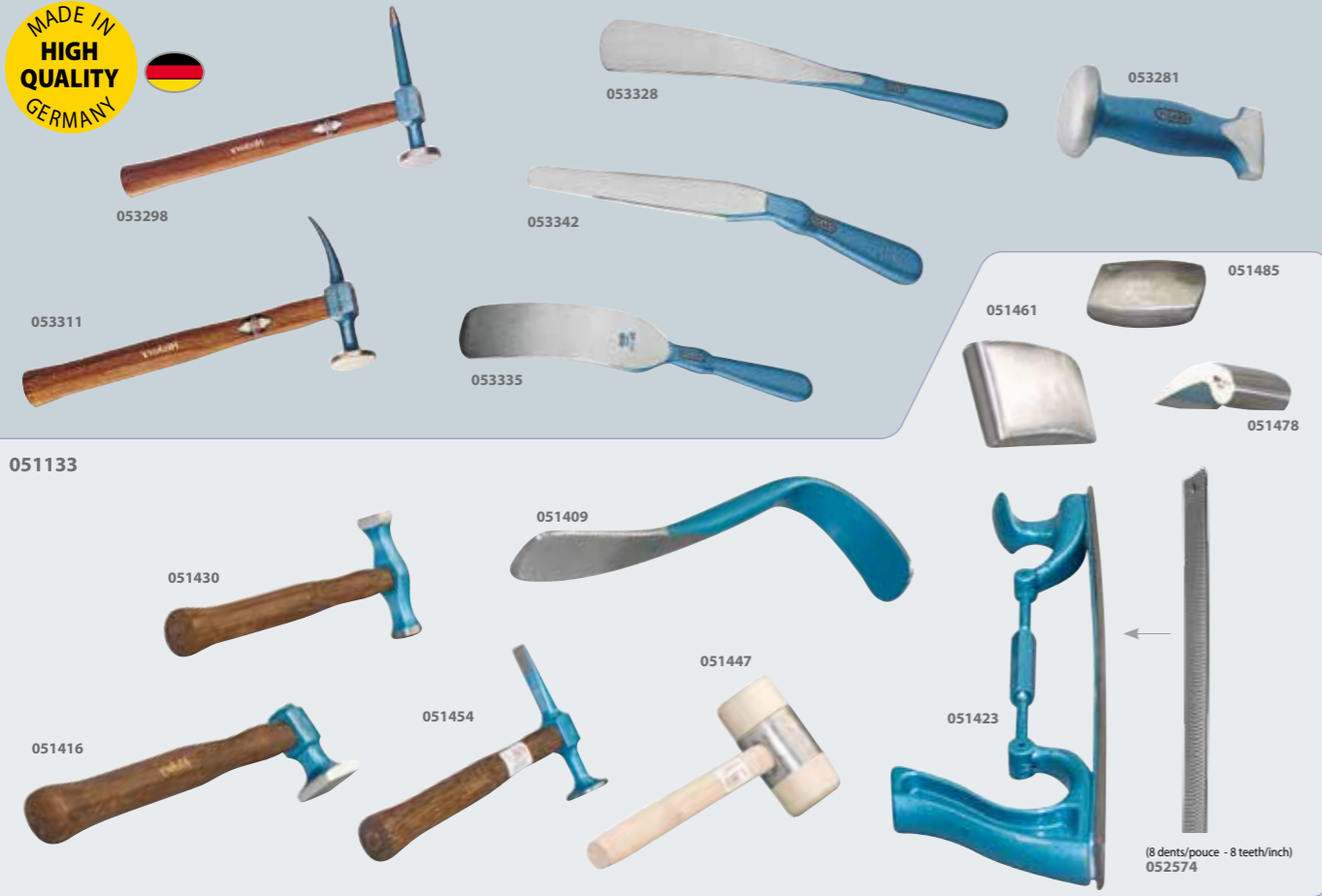

MEULEUSE D'ANGLE - Long Handled Angle Grinder - Druckluft-Winkelschleifer

NEW 2017

Ø 100 mm

± 1.6 mm, x5
057883
± 0.8 mm, x5
058217



Speed rpm	Power W	dB	Air consumption l/min	Air pressure bar	cm	kg
14000	84	113	6.2	37	17	

COFFRET DÉCAPEUSE PNEUMATIQUE - Pneumatic surface remover Kit - Druckluftentroster-Box inkl. Zubehör

051775



Speed rpm	Power W	dB	Air consumption l/min	Air pressure bar	cm	kg
4000	500	86	102	6.2	280	1.2

MINI-MEULEUSE - Mini disc sander - Druckluftschleifer

051829



Ø 75 mm

Included (x1)
052468

Speed rpm	Power W	dB	Air consumption l/min	Air pressure bar	cm	kg
18000	200	83	171	6.2	12	0.7

MINI-MEULEUSE À RENVOI D'ANGLE - Mini Angle Grinder - Mini-Druckluftwinkelschleifer geräuschgedämpft

051867



Ø 50 mm

90°

(x1) 052772

Speed rpm	Power W	dB	Air consumption l/min	Air pressure bar	cm	kg
15000	200	86	85	6.2	18	0.75

PINCE À SOYER ET À TROUER, Ø5MM PNEUMATIQUE - Pneumatic flange / ø5 mm punching tool - Pneumatische Loch- und Absetzzange Ø 5 mm



2 in 1

Ø 5 mm

0,8 > 1,2 mm

052543

POINÇONNEUSE PNEUMATIQUE OBLONG - Pneumatic oval punching tool - Pneumatische Langloch-Blechzange

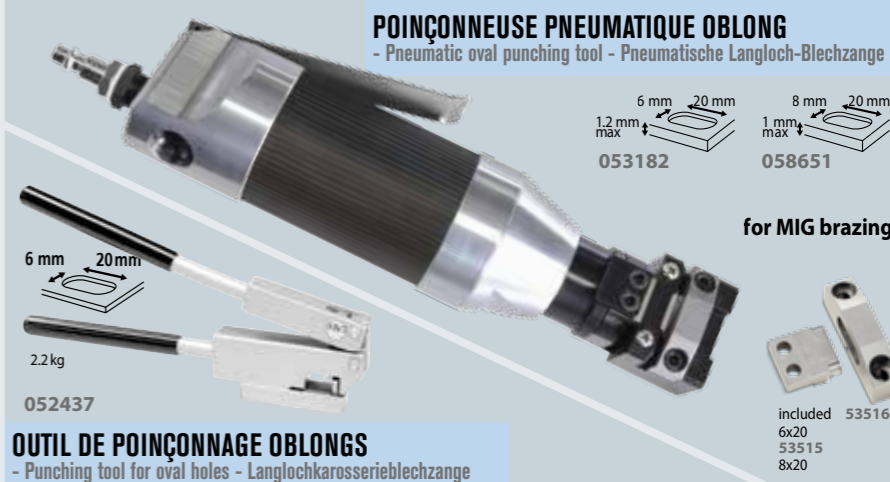

6 mm 20 mm 1.2 mm max
8 mm 20 mm 1 mm max
053182 058651

for MIG brazing

052437

OUTIL DE POINÇONNAGE OBLONGS - Punching tool for oval holes - Langlochkarosserieblechzange

Included 53516
53515
8x20

NEW 2017



x2 Ø
Ø 50 & 75 mm

Speed rpm	Power W	dB	Air consumption l/min	Air pressure bar	cm	kg
15000	84	91	6.2	10	0.6	

SCIE COUPE TÔLE DROITE ET LIME - Saw for Straight Cut and File - Druckluftsäge und Feile

051805



Included 058750

(x5) 052789

Speed rpm	Power W	dB	Air consumption l/min	Air pressure bar	cm	kg
5000	—	85	255	6.2	10	0.8

DÉPOINTEUSE - Spot remover - Druckluft-Schweißpunktbohrer



HIGH QUALITY

Forets de dépointage - Spot remover drill - Schweißpunktfräse

Tungsten Carbide for BORON/UHSS

Ø 8 mm 053069

Ø 10 mm 053076

SPOT DRILL 050464

Ø 8

Included: Tungsten Carbide for BORON/UHSS ø8 (x1)

360°

Speed rpm	Power W	dB	Air consumption l/min	Air pressure bar	cm	kg
800	400	85	140	6.5	35	2.3

BODY ZIPPER - Sertisseuse pneumatique - Pneumatic Crimper - Druckluftkantenformer

056930

MADE IN HIGH QUALITY POLAND

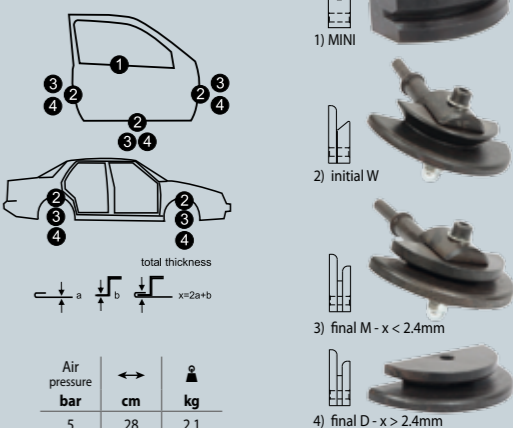

Air pressure bar	cm	kg
5	28	2.1

PONCEUSE À BANDE - Air belt sander - Druckluft Bandschleifer

052819



(x10) 052833

Speed rpm	Air consumption l/min	Air pressure bar	cm	kg
16000	171	6.3	26	0.9

MINI-FRAISEUSE À RENVOI D'ANGLE - Mini Angle Milling Machine - Mini-Winkelschleifer

051836



90°

Speed rpm	Power W	dB	Air consumption l/min	Air pressure bar	cm	kg
18000	500	81	85	6.2	18	0.7

PERCEUSE MANDRIN AUTOMATIQUE - Automatic Mandrel Drill - Druckluftbohrmaschine m. Schnellspannfutter

051799



Ø 13

Speed rpm	Power W	dB	Air consumption l/min	Air pressure bar	cm	kg
800	300	92	170	6.2	18	0.9

DÉPOINTEUSE POUR CORDON LASER ACIER & ALU - Laser cord metal sheet cutter (nibbler) - Trennwerkzeug für Lasernähte

054165



STEEL Included 054172

ALU Included 054189

TOURNEVIS SANS FIL

- Cordless Mini Screwdriver - Akkuschauber

057944

LO speed : 220 rpm - 4 Nm
HI speed : 450 rpm - 2.7 Nm
3.6 V - 1.5 Ah Li-ion battery
430 g
■ 295 x 290 x 90 mm

NEW 2017

TOURNEVIS À CHOCS SANS FIL

- Cordless Impact Screwdriver - Akkuschauber

057951

Speed : 2400 rpm
117 Nm max
14.4 V - 2 Ah Li-ion battery
1.1 kg
↓ 155 x 63 x 210 mm
■ 295 x 290 x 90 mm

NEW 2017

VISSEUSE/DÉVISSEUSE SANS FIL

- Cordless Drill/Screw Gun - Akku-Bohr-Schrauber

057937

LO/HI speed : 340/1400 rpm
26 Nm max
14.4 V - 2 Ah Li-ion battery
1.19 kg
↓ 199 x 63 x 215 mm
■ 295 x 290 x 90 mm

NEW 2017

Ø 10 mm max

RIVETEUSE SANS FIL

- Cordless Riveter - Akku-Blindnietgerät

057968

Rivets Ø 3.2 & Ø 4.0 mm (Ø 4.8 mm alu)
10.8V - 2 Ah Li-ion battery
1.16 kg
Contrôle variable de la vitesse
Balais remplaçables.
↓ 247 x 52 x 190 mm
■ 345 x 280 x 90 mm

NEW 2017

Variable speed switch

Replaceable carbon brush

PISTOLET À COLLE SANS FIL

- Cordless Caulking Gun - Akku-Kartuschenpresse

057975

Speed : 3 > 10 mm/s
Capacity : 400 ml
14.4V - 2 Ah Li-ion battery
2.75 kg
↓ 465 x 130 x 275 mm
■ 535 x 305 x 156 mm

NEW 2017

MEULEUSE/POLISSEUSE SANS FIL

- Cordless sander / polisher - Akku-Polier-Schleifer

057982

Meuleuse :
0 > 6900 rpm
Polisseuse :
0 > 1900 rpm
14.4 V - 2 Ah Li-ion battery
1.08 kg
↓ 150 x 63 x 215 mm
■ 395 x 325 x 100 mm

NEW 2017

included

75 mm

50 mm

PONÇEUSE / POLISSEUSE ÉLECTRIQUE

- Electric Sander & Polisher - Elektro-Polier-Schleifer

057999

Orbital 5.0 mm
↓ 303 x 101 mm
1.21 kg
Speed : 4000, 7000, 10000 rpm
AC-in 230V / 50Hz

NEW 2017

No vibration

Speed control

Ø 152 mm

Light weight & Compact

058293

Power supply : 220-240V
Power : 1100W
Max. vacuum : 220 mbar
Air flow : 2600 l/mn
Drum capacity : 24 L
Drum material : stainless steel
↓ 380 x 380 x 700 mm
▲ 11.2 kg

NEW 2017

Manual or automatic

4m
Input Ø 32 mm
Output Ø 38 mm

DETAILING & COLOUR MATCH - Farbanpassung & Aufbereitung

SUN COLOR

Ultra high CRI > 95 COB LED
4500 K
1100 lux
10°-70° beam angle
400 lumen
IP 65
4h operation time
3.7 V - 2600 mAh Li-ion battery
058477

NEW 2017

MATCHPEN

4000 K, 300-4000 lux
100 lumen
10°-70° beam angle
IP 54
2x AAA 1.5V
055605

Focus

Daylight lighting for perfect colour recognition

SUNMATCH

Ultra high CRI+ COB LED
4500 K
1100-550 lux (step 1-step 2)
400-180 lumen (step 1-step 2)
IP 65
1h/3h operation time
3.7 V - 2200 mAh Li-ion battery
055612

WARM 4 500 K

055940
055919



MULTIMATCH

Ultra high CRI COB LED
4500 K
3500-1400 lux (step 1-step 2)
2000-600 lumen (step 1-step 2)
IP 67
1h/6h operating time
11.1 V - 4400 mAh Li-ion battery
055629

WARM 4 500 K

055957
055926

supply 5 m

SUNMATCH 2

Ultra high CRI+ COB LED
4500/6500 K
1100-550 lux (step 1-step 2)
500-250 lumen (step 1-step 2)
IP 65
1h/2h operation time
3.7 V - 2600 mAh Li-ion battery
057777

WARM 4 500 K
COLD 6 500 K

NEW 2017

MULTIMATCH 2

Ultra high CRI+ COB LED
4500/6500 K
5000 lux (@0.5 m)
250-2500 lumen
IP 67
1h/14h operating time
11.1 V - 4400 mAh Li-ion battery
057784

WARM 4 500 K
COLD 6 500 K

NEW 2017

supply 5 m

057807

adjustable
0.7 > 1.9 m

NEW 2017

SCANGRIP®
COLOUR MATCH

Discover it on Youtube



BALADEUSE LED

- Rechargeable 15W Portable LED Lamp with Magnetic Stand - LED-Akkuarbeitsleuchte

15W LED COB
2.5h operating time
3.7 V, 2200 mAh Li-ion battery
375 x 40 x 30mm
057760
058309

NEW 2017

180°

360°

USB charge

included

LAMPE SOUS CAPOT

- Under Bonnet Work Lamp + Tripod - LED-Stativ-Akkuarbeitsleuchte klappbar

120 LEDs
800 lumen
3h/6h operating time
3.7 V - 4000 mAh Li-ion battery
058002
058316

NEW 2017

115 cm

15 cm



TRÉTEAUX - Frames support - Klappbücke

040601
100.5 x 112 cm - 5.5 kg
35 x 95 x 106 cm

040311
104.5 x 117 cm - 8.1 kg
32 x 10 x 106 cm

040250
100 x 105 cm - 7 kg
32 x 10 x 106 cm

040304
104.5 x 108.8 cm - 8.1 kg
32 x 10 x 106 cm

Léger et très maniable
Spécial travaux à l'horizontal
- Light and easy to handle
Ideal for horizontal works
- Speziell geeignet für Arbeiten in horizontaler Position

4 pieds coudés
Idéal sur callebotis
- Bent feet for grating
- Abgewinkelte Standfüße:
Sicherer Stand auf Gittern u.ä.

Ø28 mm

Ø32 mm

Ø32 mm

Ø32 mm

4 ventouses
Dépose vitrages
- Suction pad for glazing
- Gummiteiler zur Fixierung von Glasscheiben

Chainette réglable
- Adjustable catenary

Mousse de protection
- Protecting foam

Antidérapants
- Non-slip base

SUPPORT ÉLÉMENT ROTATIF

- Rotary element support - Lackierständer für Stoßstange, einstellbar

052611
200 x 101 cm - 17.5 kg
35 x 15 x 110 cm
Made in China

1.5 mm

2 mm

360°

Verrouillage de l'axe
- Locking of the axis
- Verriegelung der Achse

PRO
056725
200 x 105 x 81 cm - 22 kg
24 x 17 x 118 cm

MADE IN HIGH QUALITY POLAND

SUPPORT PARE-CHOCS - Rotary element support - Lackierständer für Stoßstange, einstellbar

052376
91 x 105 cm - 7.6 kg
60 x 11 x 75 cm

Adapté aux coques de rétroviseurs
- Adapted to wing mirror covers
- Geeignet für Außenspiegel

TIGES DE BLOCAGE - Flap Lock

056732

30 > 115 cm

CHARIOT DE LUXE MAROUFLAGE

- Premium masking machine - Abdeckpapier-Ständer

MADE IN HIGH QUALITY POLAND

x 5
rouleaux de papier
- Papierständer
- Paper roll
30 > 120 cm

057333
150 x 133 x 62 cm
32 kg
152 x 17 x 29 cm

Ø40 mm
x 6
058897

CHARIOT DE MAROUFLAGE

- Masking machine - Abdeckpapier-Ständer

MADE IN HIGH QUALITY POLAND

x 3
rouleaux de papier
- Papierständer
- Paper roll
30, 60, 90 cm

056954
150 x 62 x 110 cm
- 12 kg
122 x 29 x 17 cm

CHARIOT DE STOCKAGE

- Storage trolley - Lagerrollwagen

040243

71 x 90 x 197 cm
41 kg
x2:
91 x 147 x 6 cm
+ 69 x 93 x 44 cm

TABOURET

- Round Stool with Tool Storage - Werkstatt-Rollhocker

NEW 2017

057555
38 x 38 x 44 cm - 6 kg
40 x 40 x 18 cm

LÈVE ROUE - Wheel Lift Trolley

- Hydraulischer Radmontage-Heber

NEW 2017

057920
60 kg
151 x 42 x 19 cm

60 kg max

230 mm max

460 > 700 mm

LÈVE ROUE SUR BATTERIE

- Wheel lift trolley with battery - Radmontage-Heber mit Akkubetrieb

NEW 2017

058545
98 kg
66 x 69 x 172 cm
80 x 80 x 180 cm - 112 kg

2 x 12V/12 Ah
Integrated charger (16 A)

35 > 340 mm max

500 > 800 mm

400 mm

130 mm

60 kg max

CHARIOT DE VISITE - Mechanics Creeper With Tilting Headrest - Werkstatt-Rollliege

NEW 2017

057548
102 x 43 x 11 cm
7.2 kg
11 x 44 x 13 cm

MARCHE PIED - Folding Step Stool (Aluminium) - Arbeitspodest klappbar

NEW 2017

057562
8.2 kg
102 x 41 x 59 cm

ALU

200 kg

475 mm

ALU

NEW 2017

058552
15.5 kg
116 x 43 x 17 cm - 16.5 kg

ALU

1090 > 1750 mm

520 > 900 mm

300 mm

COUVERTURE ANTI-CHALEUR - Heat cover - Hitzeschutzdecke - Manta anti-calor - Protecção anti-aquecimento



PROTEC 550
550°C/1000°F - Class M0
2 m x 2 m - 580 g/m²
050495

PROTEC 1200
1200°C/2200°F - Class M0
1.75 m x 1.5 m - 1200 g/m²
050204

PROTEC 1300
1300°C/2400°F - Class M0
XL : 2 m x 1.8 m - 620 g/m²
053595

PROTEC 1300L
1300°C/2400°F
XL : 2 m x 1.8 m - 427 g/m²
060500

JEU DE 2 AIMANTS

- Set of 2 magnets -
Schweißmagnet



(x2)
052291

RIDEAU DE SOUDAGE
- Welding curtain and frame - Schweißerschutzwand

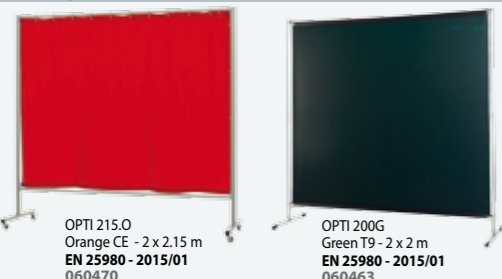

OPTI 215.0
Orange CE - 2 x 2.15 m
EN 25980 - 2015/01
060470

OPTI 200G
Green T9 - 2 x 2 m
EN 25980 - 2015/01
060463

LUNETTES DE PROTECTION - Protection goggles - Schutzbrillen

Antiprojection/meulage - Anti-projection/
grinding - Anti-proyección/amoladura -
Spritzschutz/Schleifen

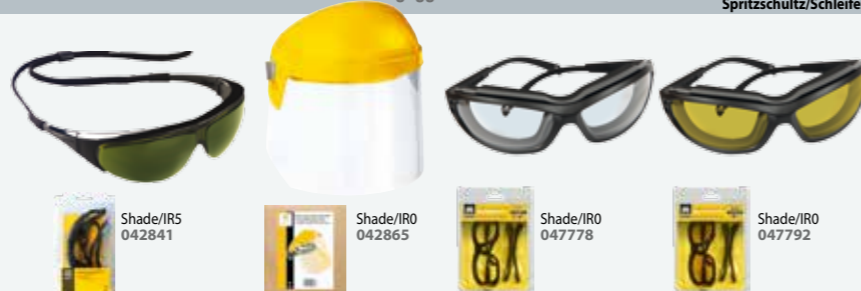

Shade/IR5
042841

Shade/IR0
042865

Shade/IR0
047778

Shade/IR0
047792

MASQUES RESPIRATOIRES - Respiratory masks - Atemschutzmaske - Máscaras respiratorias



FFP3 - EN 140 / EN 143 / EN 166
(x1) Size M/L
037021

FFP3 - EN 140 / EN 143
(x1) Size M/L
037014

Étui / Case
037045

FFP3 - EN 143 : 2000 P3
Anti poussières / Anti odeurs
037038

FFP1
(x20) EN 149-2001
043916

FFP2D-OV
M/L (x5) EN 149-2001
043923

VESTE - Jacket - Jacke

PANTALON - Trouser - Hose

TABLIER CUIR MULTI-USAGE
- Multi-use leather apron -
Delantal de cuero multi-uso -
Mehrzweck-Lederschürze

GANTS - Gloves - Handschuhe - Guantes



98% cotton, 2% antistatic
S (40/42) 046313
M (44/46) 046320
L (48/50) 046337
XL (52/54) 046344
XXL (56/58) 046351

98% cotton,
2% antistatic
S (40/42)
046368
M (44/46)
046375

L (48/50)
046382
XL (52/54)
046399
XXL (56/58)
046412



PRO
045217



EN388:
2003
4244

EN12477:
2001
4244XX

Heavy Duty
T10
(MIG - Plasma)
045101

Gants de soudage
Renforcés
- Reinforced
welding gloves :
T10
045873

Gants Manutention
Anti coupure
- Anti-cut handling
gloves :
EN388:4343
T9
045897

T10 :
045927

Anti coupure haute
résistance - High
resistance anti-cut
handling gloves :
EN 420
EN 388:3131
T9 :
045910

Anti coupure haute
dextérité - High
precision anti-cut
handling gloves :
EN 420
EN 388:3111
T9 :
045903

T10 :
045934

ASPIRATEURS DE FUMÉE - Fume Extraction Systems - Rauchgasabsauggerät



• 230V / 1 ~ / 50 Hz
• 2 x 1000 W
• AUTOMATIC ON/OFF
039896

2.5 m
(included)

• 230V / 1 ~ / 50 Hz
• 1100 W
• 1200 m³/h max
• arm 3 m
• included
• 85 kg
046474

Breveté - Patented
Welding detection
Automatic ON/OFF
230 V connection

792 mm

347 mm

Options
039889
5 m (included)
040656

039872
Filtre - Filter
039865

040649
(included)
046498

• 400V / 3 ~ / 50 Hz
• 1100 W
• 1300 m³/h max
• arm 3 m
• no plug
• 100 kg
046443

Filtre - Filter
(included)
046467

• 230V / 1 ~ / 50 Hz
• 1100 W
• 200 m³/h max
• 190 mbar max
• 26 kg / 390 x 210 x 500 mm
• 71 db
• Système de nettoyage
automatique du filtre

Automatic ON/OFF
Manual
043237
043244

150 A, 3m, Grip
043251

+ = 100 m³/h

**BATTERY SUPPORT UNIT (BSU)
BATTERY CHARGER**



	GYSFLASH 30.12 HF	12V
	30 A	
029224		
	GYSFLASH 30.24 HF	12V
	30 A	6/12/24V
029231		
	GYSFLASH 40.12 FV	12V
	40 A	
029064		
	GYSFLASH 50.12 HF	12V
	50 A	
029088		
	GYSFLASH 50.24 HF	12V
	50 A	6/12/24V
029095		
	GYSFLASH 100.12 HF	12V
	100 A	
029071		



1 044 40004

10.5 cm

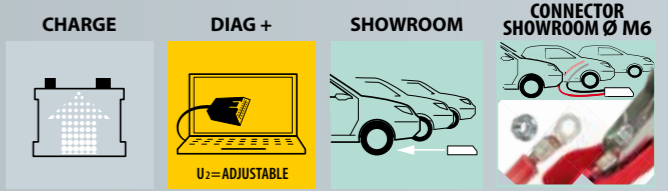

AUTO DETECT

MICRO-PROCESSOR CONTROL

Protection for on-board electronics

TECHNOLOGY & ADVANTAGES

100%
50% de gain de temps + batterie chargée à 100%
50% of time saved + battery 100% charged
50% Zeitersparnis + 100% Vollladung
ahorro de tiempo de 50% + batería cargada a los 100%

HIGH EFFICIENCY
Up to 15% Energy Saving
93%

EMC class B

POWER FACTOR CORRECTION

185V
265V
100m

EASY MODE

FAN LESS TECHNOLOGY

SULPHATED BATTERIES

AUTOMATIC RECOVERY



EXTENSIONS CABLES

Gysflash 30/40/50/100/102
5 m - 16 mm²
054615

8 m - 16 mm²
056572



VALISE DE CHANTIER / HEAVY-DUTY CASE / HARTSCHALENKOFFER

060432
↓ 21 x 43 x 57 cm / 3.9 kg

IP67



TABLETTE / WALL SUPPORT / WANDHALTERUNG

055513

SAFETY PROTECTION & BATTERY EQUIPMENT





GYSFLASH 102.12 HF PFC
100 A 12V
 029606

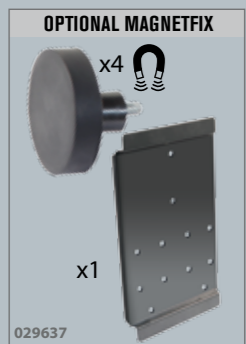
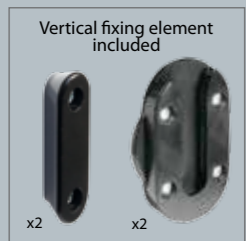

CHARGE DIAG + SHOWROOM

U₂=ADJUSTABLE

MEMORY SAVER

230V/12V 055018

230V

PROTECTION ANTI-ARC 12V
 - Anti-arc protection 12V - Lichtbogenschutz 12V - Protección anti-arco 12V

041318



DÉBOSSSELAGE - Dent pulling - デントプラー

GYSLOT 2600 page 6	GYSLOT 2700 page 6	GYSLOT 39.02 page 6	GYSLOT PRO 230 page 7	GYSLOT EXPERT 200 page 7	GYSLOT ALU PRO FV page 8	GYSLOT COMBI 230 PRO page 9
------------------------------	------------------------------	-------------------------------	---------------------------------	------------------------------------	------------------------------------	---------------------------------------

SOUDURE PAR POINT - Spotwelding - スポット溶接

GYSLOT BP.LQC-s7 220 V page 38	GYSLOT BP.LCX-s7 220 V page 40	GYSLOT EVOLUTION PTI-s7 220 V page 41	GYPRESS 8t page 44	GYPRESS PUSH PULL page 45
--	--	---	------------------------------	-------------------------------------

MIG/MAG TRADITIONNEL - Traditional MIG/MAG - ミグマグトラディショナル

M1GYS AUTO T1GYS AUTO DV page 50	M3GYS AUTO T3GYS AUTO DV page 50	NEOPULSE 300 page 52	NEOPULSE 300-T2 page 52	CHARGEUR - Battery charger - バッテリーチャージャー GYSFLASH 40.12 FV page 77	DÉCOUPAGE PLASMA - Plasma cutting - プラズマカッター CUTTER 31 FV page 63	CUTTER 40 FV page 63	INDUCTION - インダクション GYSDUCTION AUTO page 59
--	--	--------------------------------	-----------------------------------	---	--	--------------------------------	--

INDIAN CAR MANUFACTURER APPROVALS / COMPLIANCE

	OEM - CARS												OEM - TRUCKS				
	MAZDA	HONDA	TOYOTA	MERCEDES	RENAULT	FIAT	VOLKSWAGEN	FORD	NISSAN	JAGUAR	LAND ROVER	TATA	VOLVO	EICHER			
DENT PULLER																	
SPEEDLINER																	
GYSLOT ALU FV																	
SPOT WELDERS																	
GYSLOT 32D																	
GYSLOT INVERTER BP-MS/LX/LC/LQC																	
GYSLOT EVOLUTION PTI-s7																	
MIG / MAG																	
T1 GYS AUTO																	
T3 GYS AUTO																	
NEOPULSE																	
PLASMA																	
CUTTER 25K																	
CUTTER 31FV																	
INDUCTION																	
GYSDUCTION AUTO																	
BATTERY CHARGERS																	
TOOLS & TROLLEYS																	



Formations agréées
Ref. 52 53 0068153

Centre de formation agréé
Training centre dedicated to professionals
Trainingcenter für Profis

🇫🇷 GYS France (HQ)

BP 4159
53941 Saint-Berthevin
ZI, 134 bd des Loges
Laval
France
Fax : (+33) 2 43 68 35 21

www.gys.fr
E-mail : contact@gys.fr

🇩🇪 GYS Germany

Professor-Wieler-Straße 11
52070 Aachen
Deutschland
Tel : (+49) 241 / 189-23-710
Fax : (+49) 241 / 189-23-719
www.gys-schweissen.com
E-mail : aachen@gys.fr

🇬🇧 GYS UK

Unit 3
Great Central Way
Rugby - Warwickshire - CV21 3XH
United Kingdom
Tel : (+44) 1926 338 609
Fax : (+44) 1926 429 764
www.gys-welding.com
E-mail : uk@gys.fr

🇮🇹 GYS Italia

C.P. 158 - Mestre Centro
30171 Mestre-Venezia
Italia
Tel : (+39) 340 3677916
E-mail : italia@gys.fr

🇮🇳 GYS India

796/1A-A, Avinashi road
opp to Decathlon
Neelambur, Coimbatore
641062 Tamil Nadu
India
Tel : +91. 88708. 71111
E-mail : s.kumar@gys.fr

🇨🇳 GYS China

Lot N°15
6666 bd Songze
201706 Qingpu Shanghai
China
Tel : (+86) 6221 4461
Fax : (+86) 5226 0067
www.gys-china.com.cn
E-mail : contact@gys-china.com.cn

🇨🇳 Bao Zhi Long Electrical Equipment (JV GYS)

Building C1,
No. 479 Chundong Rd
Minhang District, Shanghai
China
Tel : (+86) 52217650
Tel2 : (+86) 52217651
Tel3 : (+86) 52217652
Fax : (+86) 52217653
www.bzl-china.com
E-mail : mz@bzl-china.com

www.gys.fr



Distributed by

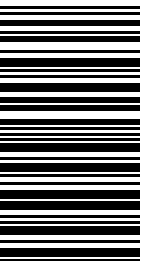

Document non contractuel. GYS se réserve le droit de modifier sans préavis les spécifications de ses appareils - Document not contractual.
GYS reserves the right to modify the specifications of the machines without prior notice. Irrtümer und Änderungen vorbehalten.